

2008 Prairie 360 4X4 Hardwoods Green HD PARTS DIAGRAM

Gear Change Mechanism

E1370

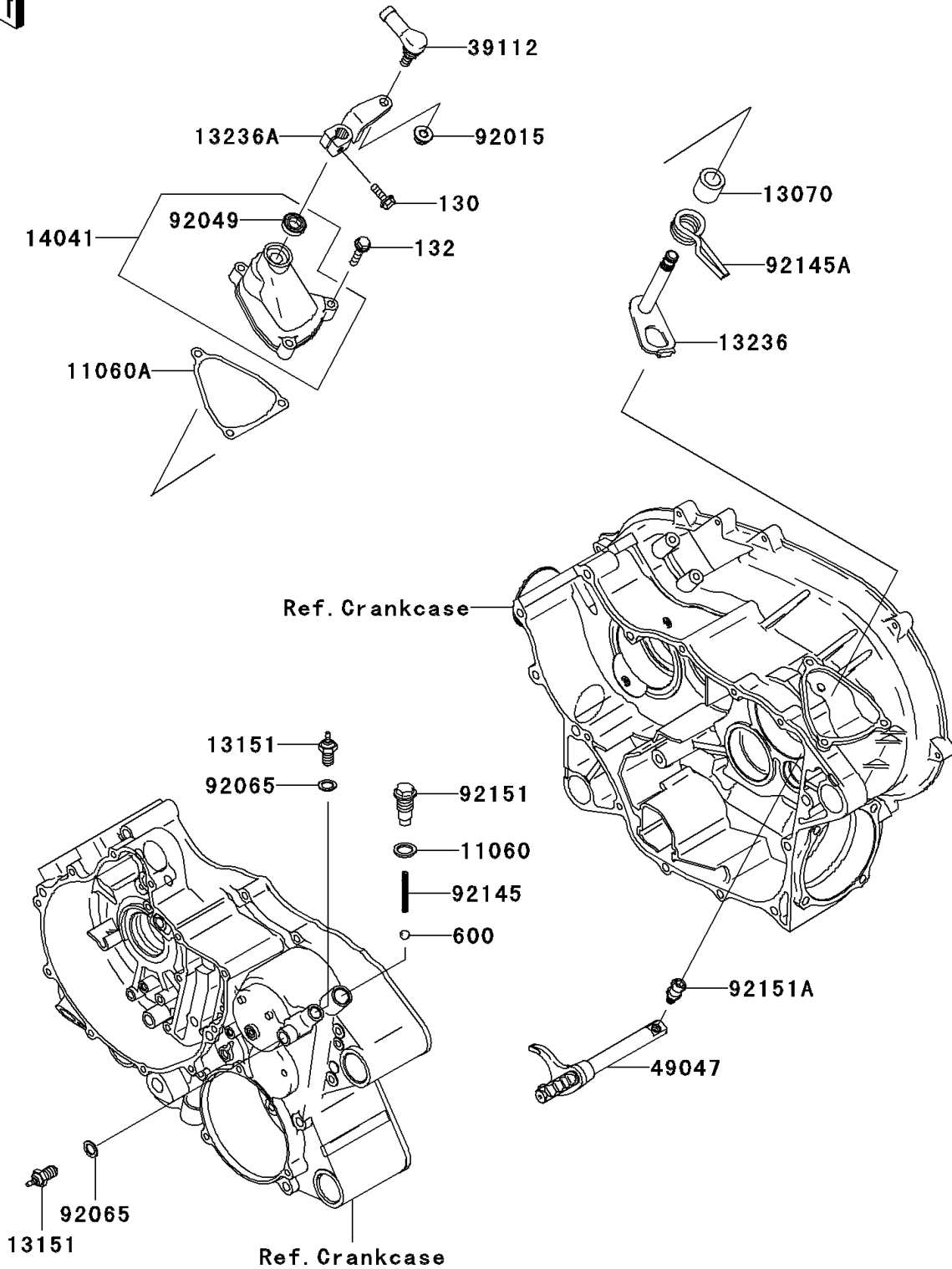

2008 Prairie 360 4X4 Hardwoods Green HD PARTS LIST

Gear Change Mechanism

ITEM NAME	PART NUMBER	QUANTITY
BOLT-FLANGED,6X20 (Ref # 130)	130CD0620	1
BOLT-FLANGED-SMALL,6X30 (Ref # 132)	132BD0630	3
BALL-STEEL,5/16" (Ref # 600)	600A1000	1
GASKET,14X20X2 (Ref # 11060)	11060-1287	1
GASKET,CHANGE LEVER COVER (Ref # 11060A)	11060-1956	1
GUIDE (Ref # 13070)	13070-1352	1
SWITCH-COMP,NEUTRAL (Ref # 13151)	13151-1080	2
LEVER-COMP,CHANGE (Ref # 13236)	13236-0051	1
LEVER-COMP,CHANGE LEVER (Ref # 13236A)	13236-1400	1
COVER-COMP,CHANGE LEVER (Ref # 14041)	14041-1136	1
RODEND-TIE,CHANGE LEVER (Ref # 39112)	39112-1080	1
ROD-SHIFT (Ref # 49047)	49047-1104	1
NUT,8MM (Ref # 92015)	92015-1432	1
SEAL-OIL,TB12205.5 (Ref # 92049)	92049-1271	1
GASKET,10.5X16X1 (Ref # 92065)	92065-058	2
SPRING,CHANGE POSITION (Ref # 92145)	92145-1297	1
SPRING,CHANGE LEVER (Ref # 92145A)	92145-1299	1
BOLT,CHANGE POSITION (Ref # 92151)	92151-1687	1
BOLT,SHIFT ROD (Ref # 92151A)	92151-1699	1