

2016 KX™ 250F PARTS DIAGRAM

Owner's Tools

F2810

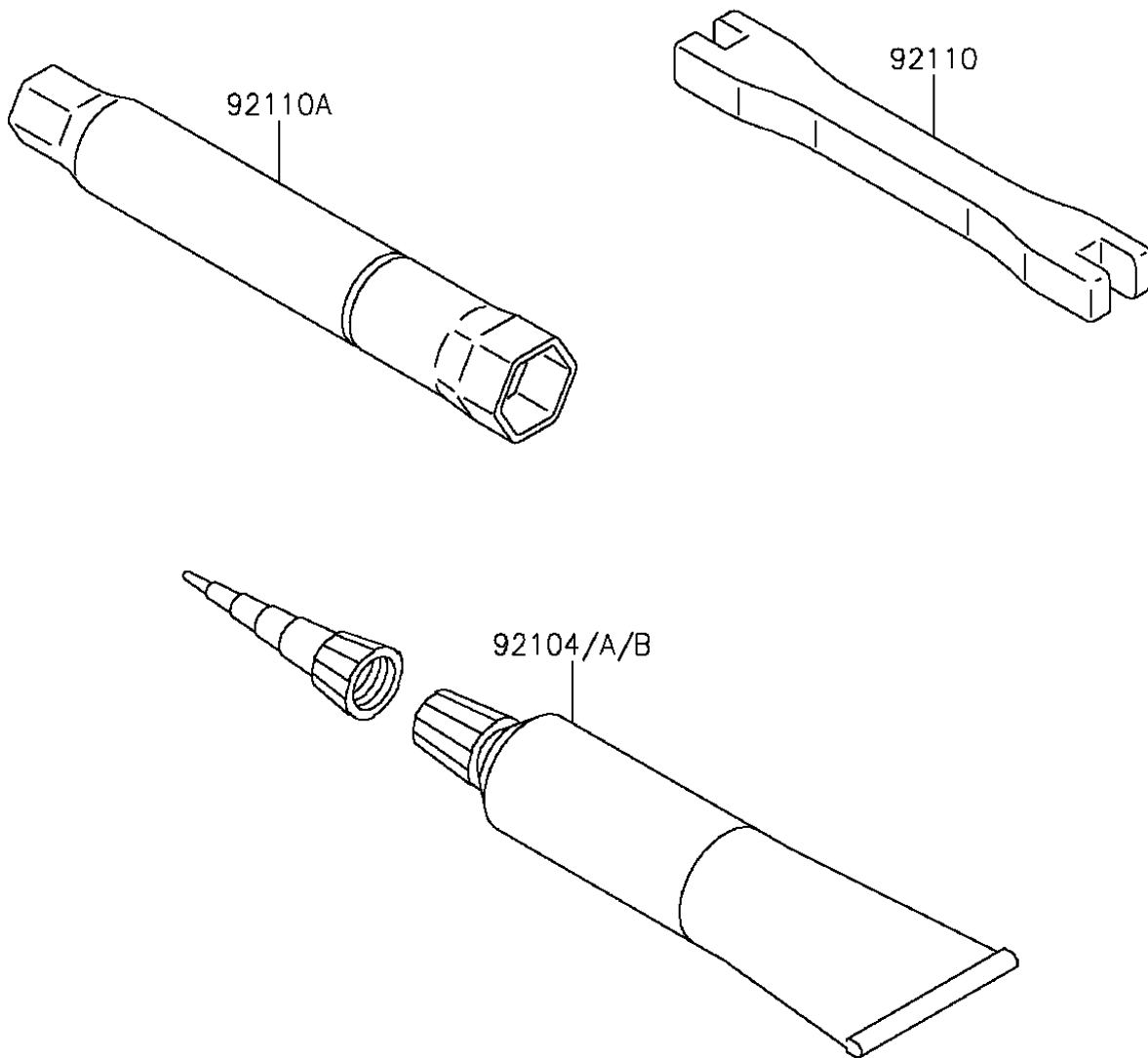

2016 KX™ 250F PARTS LIST

Owner's Tools

ITEM NAME	PART NUMBER	QUANTITY
-----------	-------------	----------