

2001 Prairie 300 PARTS DIAGRAM

Crankcase

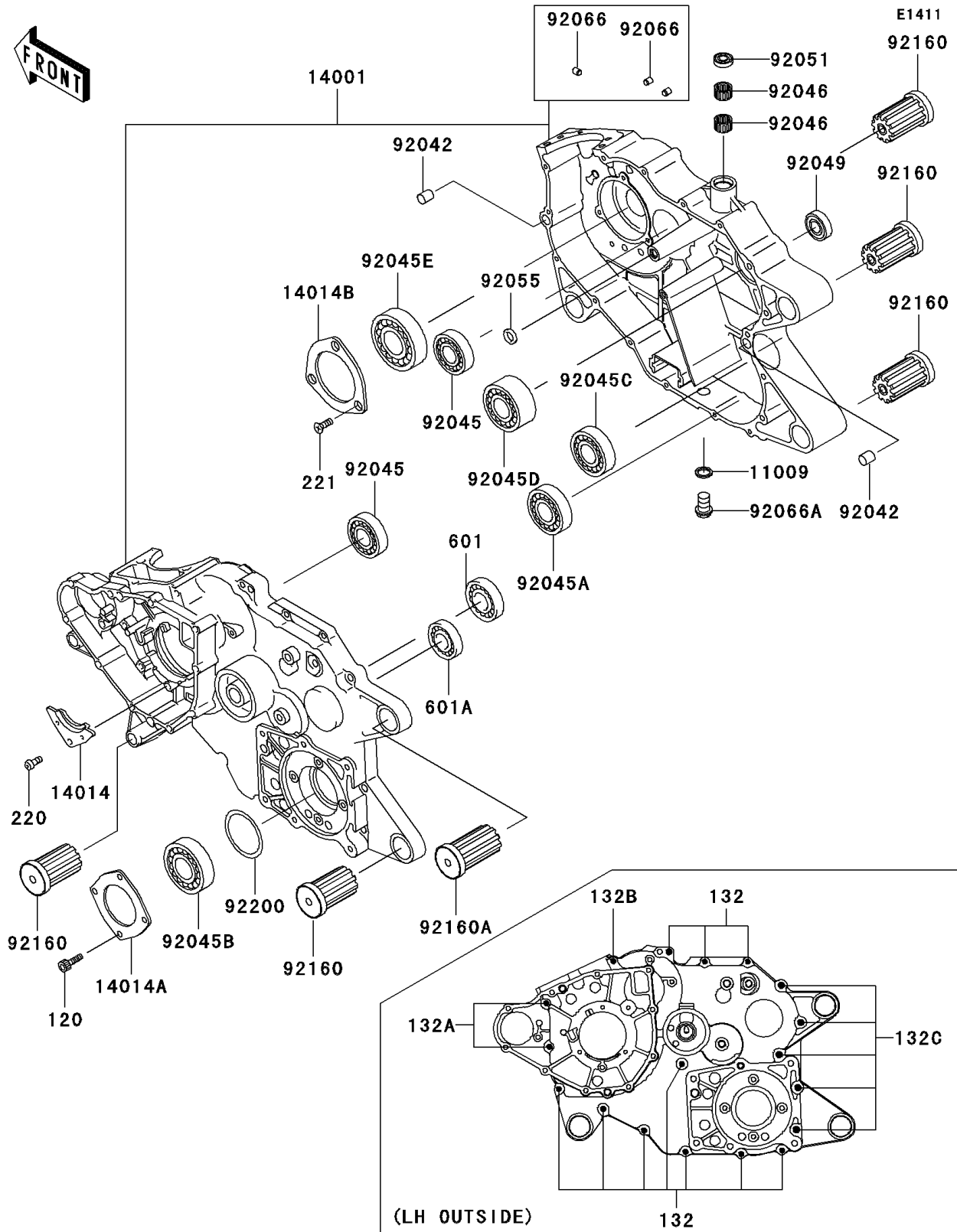

2001 Prairie 300 PARTS LIST

Crankcase

ITEM NAME	PART NUMBER	QUANTITY
BOLT-SOCKET,6X16 (Ref # 120)	120P0616	1
BOLT-FLANGED-SMALL,6X35 (Ref # 132)	132Y0635	1
BOLT-FLANGED-SMALL,6X65 (Ref # 132A)	132Y0665	1
BOLT-FLANGED-SMALL,6X85 (Ref # 132B)	132Y0685	1
BOLT-FLANGED-SMALL,8X35 (Ref # 132C)	132Y0835	1
SCREW-PAN-CROS,6X12 (Ref # 220)	220B0612	1
SCREW-CSK-CROS,6X16 (Ref # 221)	221B0616	1
BEARING-BALL (Ref # 601)	601A6204Z	1
BEARING-BALL (Ref # 601A)	601A6302	1
GASKET (Ref # 11009)	11009-2175	1
SET-CRANKCASE (Ref # 14001)	14001-1242	1
PLATE-POSITION,CAM CHAIN (Ref # 14014)	14014-035	1
PLATE-POSITION (Ref # 14014A)	14014-1108	1
PLATE-POSITION (Ref # 14014B)	14014-1137	1
PIN,DOWEL,12X14 (Ref # 92042)	92042-031	1
BEARING-BALL,6004TMB (Ref # 92045)	92045-1118	1
BEARING-BALL,TMB304CCM (Ref # 92045A)	92045-1142	1
BEARING-BALL,6305RHR4SH2 (Ref # 92045B)	92045-1254	1
BEARING-BALL,6204X15C (Ref # 92045C)	92045-1298	1
BEARING-BALL,5206 (Ref # 92045D)	92045-1329	1
BEARING-BALL,63/32C3 (Ref # 92045E)	92045-1364	1
BEARING-NEEDLE,HK1312 (Ref # 92046)	92046-1148	1
SEAL-OIL,TC30458 (Ref # 92049)	92049-1451	1
SEAL-OIL,TB13225.5 (Ref # 92051)	92051-005	1
RING-O,OD=18 (Ref # 92055)	92055-048	1
PLUG,OIL LINE,7.2X8 (Ref # 92066)	92066-1012	1
PLUG,DRAIN (Ref # 92066A)	92066-2196	1
DAMPER,L=63.5 (Ref # 92160)	92160-1938	1
DAMPER,L=70 (Ref # 92160A)	92160-1939	1

2001 Prairie 300 PARTS LIST

Crankcase

ITEM NAME	PART NUMBER	QUANTITY
WASHER,50X60.5X0.5 (Ref # 92200)	92200-1106	1