

2018 BRUTE FORCE® 750 4x4i EPS PARTS DIAGRAM

Meter(s)

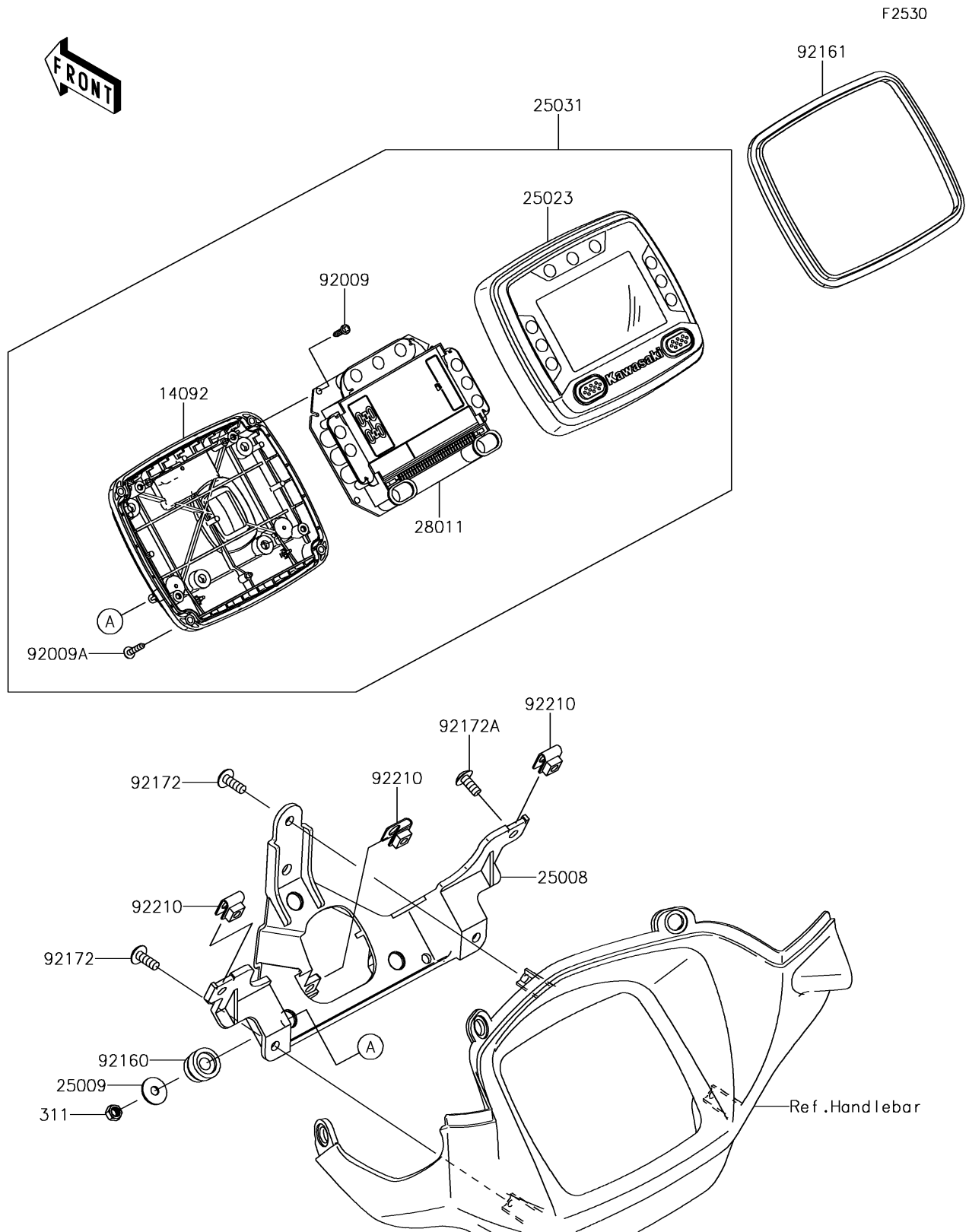

2018 BRUTE FORCE® 750 4x4i EPS PARTS LIST

Meter(s)

ITEM NAME	PART NUMBER	QUANTITY
COVER,LWR CASE (Ref # 14092)	14092-0179	1
BRACKET-METER (Ref # 25008)	25008-0034	1
WASHER,5.2X16X1.2 (Ref # 25009)	25009-004	1
COVER-METER CASE,UPP (Ref # 25023)	25023-0069	1
METER-ASSY,LCD (Ref # 25031)	25031-0473	1
METER,LCD (Ref # 28011)	28011-0603	1
NUT-HEX,5MM (Ref # 311)	311AA0500	1
SCREW,3X12 (Ref # 92009)	92009-1326	1
SCREW,TAPPING,3X16 (Ref # 92009A)	92009-1391	1
DAMPER (Ref # 92160)	92160-1460	1
DAMPER,METER (Ref # 92161)	92161-0906	1
SCREW,TAPPING,5X14 (Ref # 92172)	92172-0265	1
SCREW,5X12 (Ref # 92172A)	92172-0806	1
NUT,5MM (Ref # 92210)	92210-0899	1