

2018 BRUTE FORCE® 750 4x4i EPS PARTS DIAGRAM

Frame Fittings

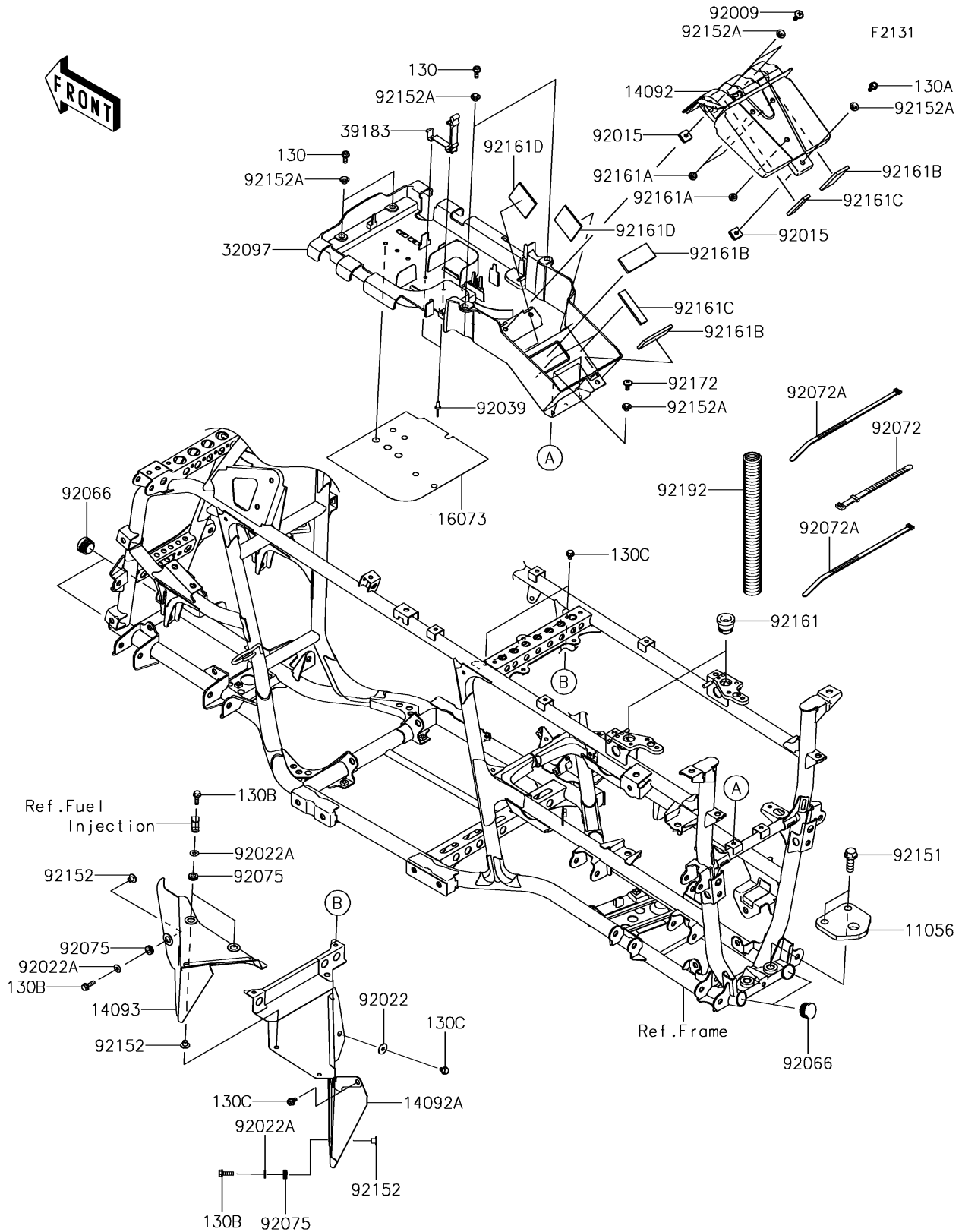

2018 BRUTE FORCE® 750 4x4i EPS PARTS LIST

Frame Fittings

ITEM NAME	PART NUMBER	QUANTITY
BRACKET,TRAILER HITCH (Ref # 11056)	11056-0299	1
BOLT-FLANGED,6X16 (Ref # 130)	130BA0616	4
BOLT-FLANGED,6X18 (Ref # 130A)	130BA0618	1
BOLT-FLANGED,6X20 (Ref # 130B)	130BA0620	4
BOLT-FLANGED,6X10 (Ref # 130C)	130BD0610	4
COVER,BATTERY (Ref # 14092)	14092-0189	1
COVER,HEAT GUARD,FR (Ref # 14092A)	14092-0897	1
COVER,HEAT GUARD (Ref # 14093)	14093-0021	1
INSULATOR,BATTERY CASE (Ref # 16073)	16073-0809	1
CASE-BATTERY (Ref # 32097)	32097-0041	1
BAND-ASSY,TOOL BAG (Ref # 39183)	39183-1065	1
SCREW,6X20 (Ref # 92009)	92009-1289	2
NUT,6MM (Ref # 92015)	92015-1094	3
WASHER,6.5X20X1.6 (Ref # 92022)	92022-1804	1
WASHER,6.2X15X1.2 (Ref # 92022A)	92022-2373	4
RIVET,4.8MM (Ref # 92039)	92039-3719	2
PLUG (Ref # 92066)	92066-0036	4
BAND,L=186 (Ref # 92072)	92072-056	1
BAND,L=292.1 (Ref # 92072A)	92072-3509	2
DAMPER (Ref # 92075)	92075-2097	4
BOLT,FLANGED,12X35 (Ref # 92151)	92151-1903	2
COLLAR,6.3X8.3X9.2 (Ref # 92152)	92152-0237	4
COLLAR,6.3X8.3X7.2 (Ref # 92152A)	92152-1865	9
DAMPER (Ref # 92161)	92161-0048	2
DAMPER (Ref # 92161A)	92161-1084	3
DAMPER,30X70X5 (Ref # 92161B)	92161-1127	3
DAMPER,15X70X5 (Ref # 92161C)	92161-1380	3
DAMPER,50X50X3 (Ref # 92161D)	92161-1386	2
SCREW,6X14 (Ref # 92172)	92172-0401	2

2018 BRUTE FORCE® 750 4x4i EPS PARTS LIST

Frame Fittings

ITEM NAME	PART NUMBER	QUANTITY
TUBE,CORRUGATED,25.5X32.25X300 (Ref # 92192)	92192-1042	1