

2000 Prairie 300 4X4 PARTS DIAGRAM

Engine Mount

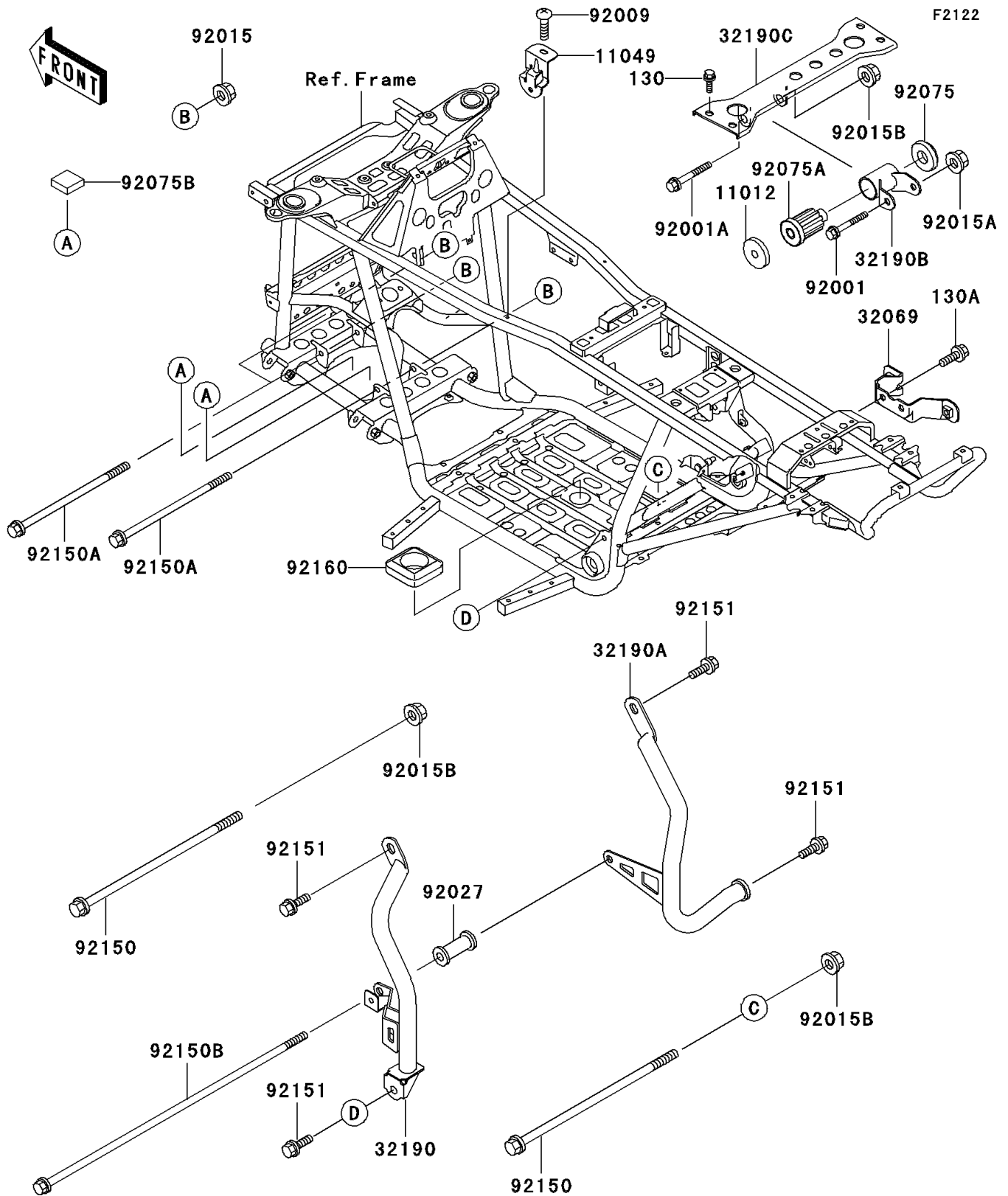

2000 Prairie 300 4X4 PARTS LIST

Engine Mount

ITEM NAME	PART NUMBER	QUANTITY
BOLT-FLANGED,8X12 (Ref # 130)	130J0812	1
BOLT-FLANGED,8X14 (Ref # 130A)	130J0814	1
CAP,ENGINE BRACKET (Ref # 11012)	11012-1228	1
BRACKET (Ref # 11049)	11049-1738	1
BRACKET-MUFFLER (Ref # 32069)	32069-1547	1
BRACKET-ENGINE,LH (Ref # 32190)	32190-1130	1
BRACKET-ENGINE,RH (Ref # 32190A)	32190-1132	1
BRACKET-ENGINE (Ref # 32190B)	32190-1141	1
BRACKET-ENGINE (Ref # 32190C)	32190-1181	1
BOLT,FLANGED,8X60,BLACK (Ref # 92001)	92001-1615	1
BOLT,FLANGED,10X80 (Ref # 92001A)	92001-1709	1
SCREW,TAPPING,6X16 (Ref # 92009)	92009-1166	1
NUT,FLANGED,10MM (Ref # 92015)	92015-1335	1
NUT,LOCK,FLANGED,8MM (Ref # 92015A)	92015-1397	1
NUT,FLANGED,10MM (Ref # 92015B)	92015-1727	1
COLLAR,L=54 (Ref # 92027)	92027-275	1
DAMPER,ENGINE MOUNT,SIDE (Ref # 92075)	92075-1274	1
DAMPER,ENGINE MOUNT,MAIN (Ref # 92075A)	92075-1377	1
DAMPER,FUEL TANK,RR (Ref # 92075B)	92075-1483	1
BOLT,FLANGED,10X150 (Ref # 92150)	92150-1686	1
BOLT,FLANGED,10X120 (Ref # 92150A)	92150-1831	1
BOLT,FLANGED,10X205 (Ref # 92150B)	92150-1899	1
BOLT,FLANGED,10X16 (Ref # 92151)	92151-1137	1
DAMPER (Ref # 92160)	92160-1772	1