

2018 KLX450R PARTS DIAGRAM

Swingarm

F2141

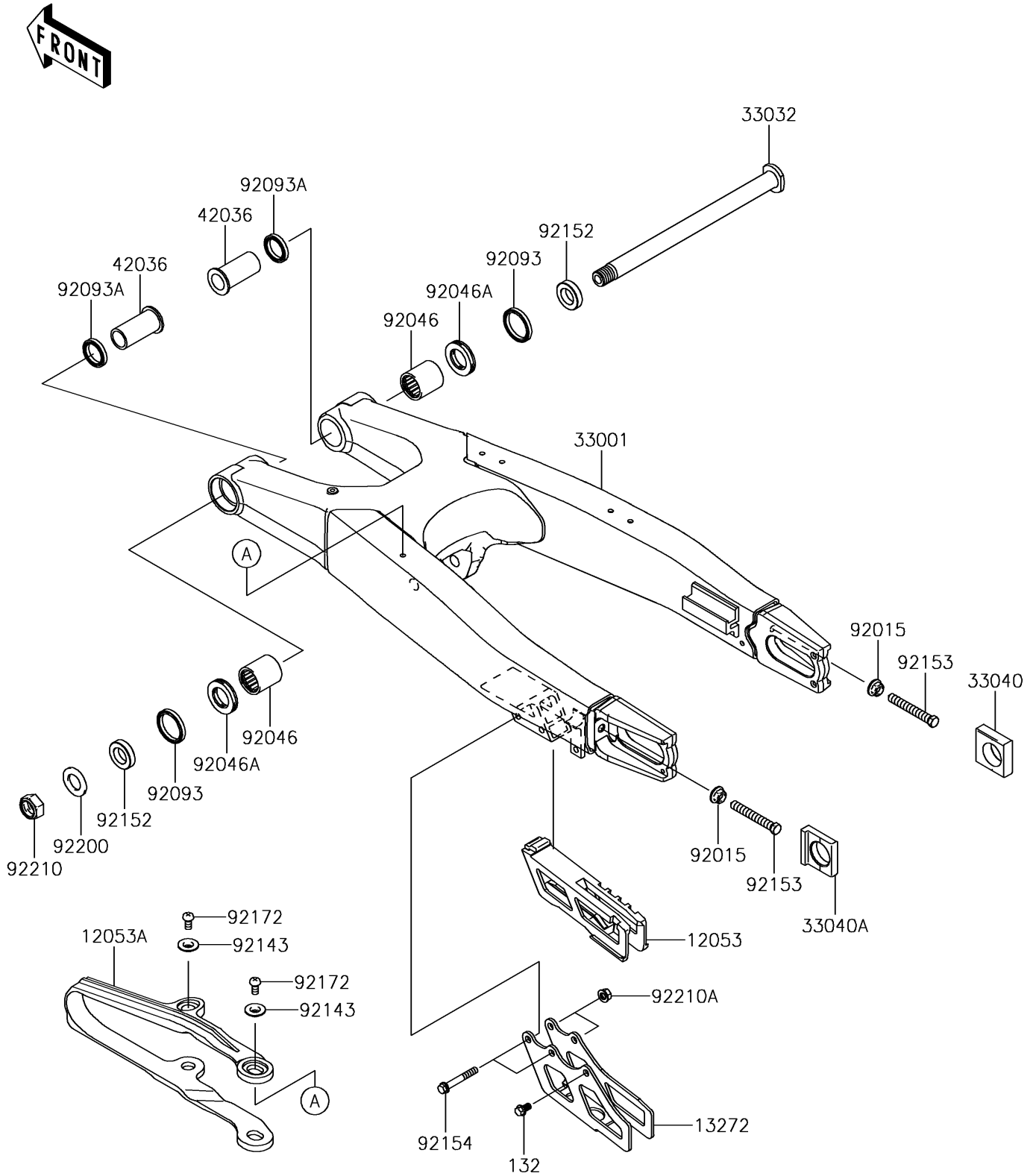

2018 KLX450R PARTS LIST

Swingarm

ITEM NAME	PART NUMBER	QUANTITY
GUIDE-CHAIN (Ref # 12053)	12053-0125	1
GUIDE-CHAIN,HARDNESS UP (Ref # 12053A)	12053-0192	1
BOLT-FLANGED-SMALL,6X10 (Ref # 132)	132BA0610	1
PLATE,CHAIN GUIDE (Ref # 13272)	13272-1169	1
ARM-COMP-SWING (Ref # 33001)	33001-0645	1
SHAFT-SWING ARM (Ref # 33032)	33032-0012	1
ADJUSTER-CHAIN,RH (Ref # 33040)	33040-0020	1
ADJUSTER-CHAIN,LH (Ref # 33040A)	33040-0075	1
SLEEVE,SWING ARM,L=47.5 (Ref # 42036)	42036-0019	2
NUT,FLANGED,8MM (Ref # 92015)	92015-1014	2
BEARING-NEEDLE,TA2230Z (Ref # 92046)	92046-1174	2
BEARING-NEEDLE,NTBR22356E01 (Ref # 92046A)	92046-1240	2
SEAL,SDO29X35X4.5 (Ref # 92093)	92093-1434	2
SEAL,SDO22X29X5 (Ref # 92093A)	92093-1435	2
COLLAR (Ref # 92143)	92143-1676	4
COLLAR,17.1X29X6 (Ref # 92152)	92152-0292	2
BOLT,8X56 (Ref # 92153)	92153-0620	2
BOLT,FLANGED,6X42 (Ref # 92154)	92154-0511	2
SCREW,5X8 (Ref # 92172)	92172-0119	4
WASHER,17.2X30X2.3 (Ref # 92200)	92200-0285	1
NUT,LOCK,16MM (Ref # 92210)	92210-0285	1
NUT,FLANGED,6MM (Ref # 92210A)	92210-0630	2