

2017 KX™250F PARTS DIAGRAM

Cables

F2540

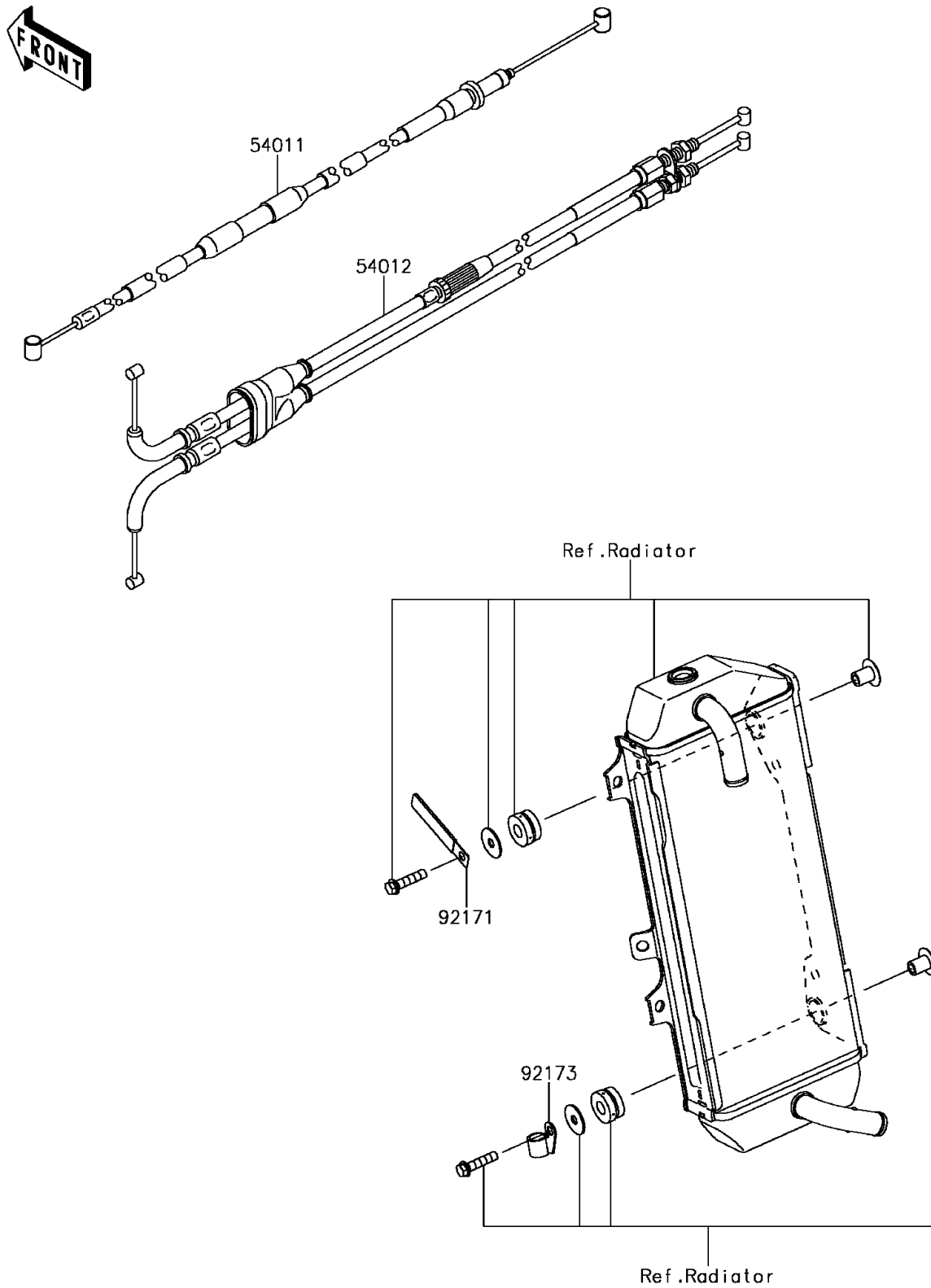

2017 KX™250F PARTS LIST

Cables

ITEM NAME	PART NUMBER	QUANTITY
CABLE-CLUTCH (Ref # 54011)	54011-0615	1
CABLE-THROTTLE (Ref # 54012)	54012-0637	1
CLAMP,L=60 (Ref # 92171)	92171-0652	1
CLAMP (Ref # 92173)	92173-1562	1