

# 2005 KFX80 PARTS DIAGRAM

Transmission

E1361

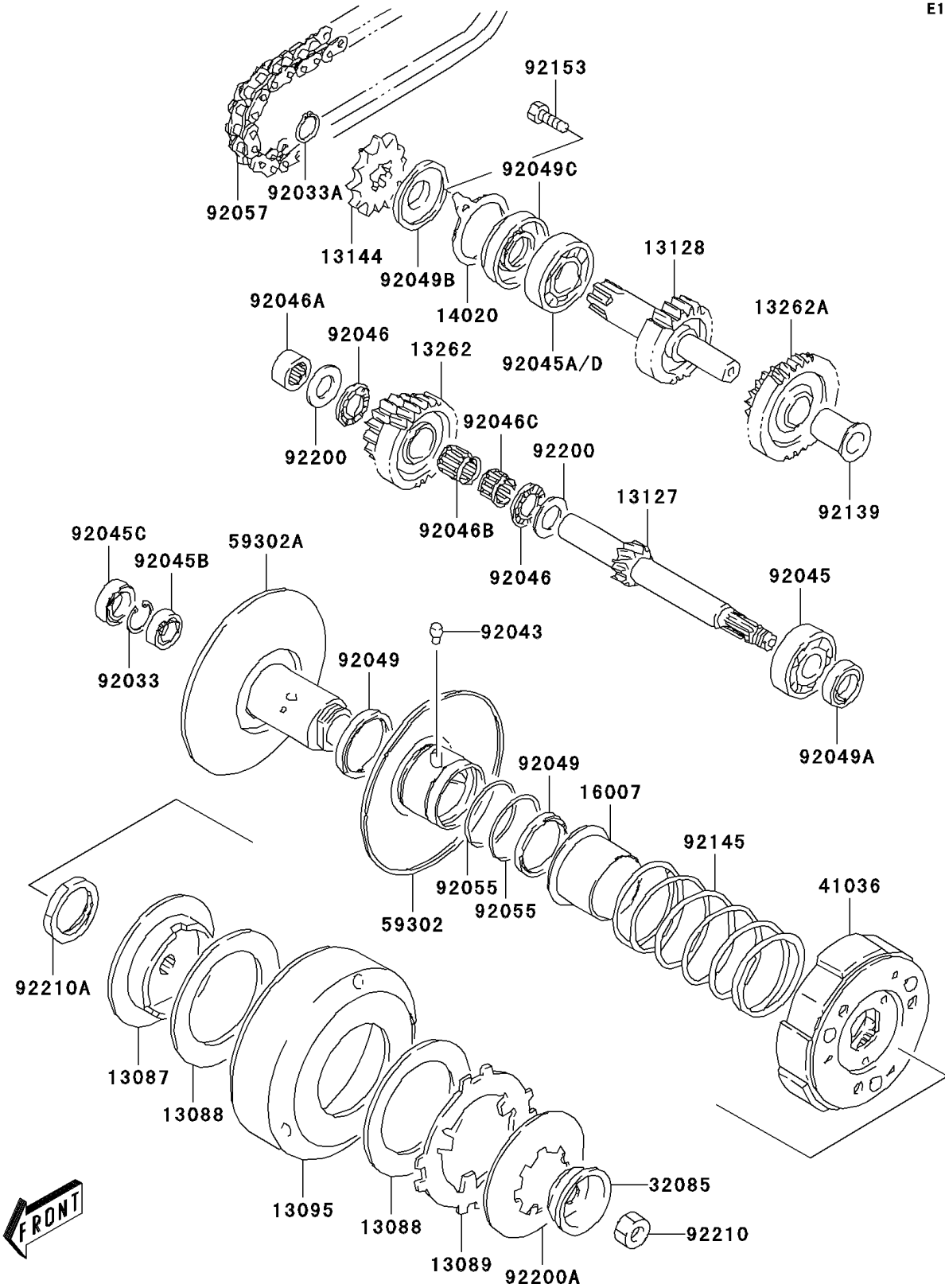

## 2005 KFX80 PARTS LIST

### Transmission

ITEM NAME	PART NUMBER	QUANTITY
HUB-CLUTCH (Ref # 13087)	13087-S002	1
PLATE-FRICTION,LIMITER CLUTCH (Ref # 13088)	13088-S002	2
PLATE-CLUTCH,LIMITER CLUTCH (Ref # 13089)	13089-S002	1
HOUSING-COMP-CLUTCH (Ref # 13095)	13095-S005	1
SHAFT-TRANSMISSION INPUT (Ref # 13127)	13127-S005	1
SHAFT-TRANSMISSION OUTPUT (Ref # 13128)	13128-S007	1
SPROCKET-OUTPUT,10T-520 (Ref # 13144)	13144-S004	1
GEAR-TRANSMISSION SPUR,FINAL (Ref # 13262)	13262-S002	1
GEAR-TRANSMISSION SPUR,IDLER (Ref # 13262A)	13262-S003	1
RETAINER,DRIVE SHAFT (Ref # 14020)	14020-S005	1
SEAT-SPRING,MOVABLE DRIVEN (Ref # 16007)	16007-S004	1
STOPPER,LIMITER CLUTCH (Ref # 32085)	32085-S006	1
HUB-ASSY (Ref # 41036)	41036-S005	1
SHEAVE-COMP,MOVABLE DRIVEN (Ref # 59302)	59302-S009	1
SHEAVE-COMP,FIXED DRIVEN (Ref # 59302A)	59302-S010	1
RING-SNAP (Ref # 92033)	92033-S004	1
RING-SNAP (Ref # 92033A)	92033-S020	1
PIN,MOVABLE DRIVEN (Ref # 92043)	92043-S030	3
BEARING-BALL,15X42X13 (Ref # 92045)	92045-S015	1
BEARING-BALL,20X47X14 (Ref # 92045A)	92045-S017	1
BEARING-BALL,FIXED DRIVEN (Ref # 92045B)	92045-S041	1
BEARING-BALL,FIXED DRIVEN (Ref # 92045C)	92045-S042	1
BEARING-NEEDLE,15X28X2 (Ref # 92046)	92046-S006	2
BEARING-NEEDLE,SHAFT (Ref # 92046A)	92046-S011	1
BEARING-NEEDLE,FINAL DRIVE (Ref # 92046B)	92046-S012	1
BEARING-NEEDLE,FINAL DRIVE (Ref # 92046C)	92046-S013	1
SEAL-OIL,MOVABLE DRIVEN (Ref # 92049)	92049-S036	2
SEAL-OIL (Ref # 92049A)	92049-S037	1
SEAL-OIL,DRIVE SHAFT (Ref # 92049B)	92049-S039	1

## 2005 KFX80 PARTS LIST

### Transmission

ITEM NAME	PART NUMBER	QUANTITY
SEAL-OIL,DRIVE SHAFT (Ref # 92049C)	92049-S045	1
RING-O,D:1.5,ID:39.7 (Ref # 92055)	92055-S020	2
CHAIN,DRIVE,36LE (Ref # 92057)	92057-S009	1
BUSHING,IDLER DRIVE (Ref # 92139)	92139-S017	1
SPRING,MOVABLE DRIVEN FACE (Ref # 92145)	92145-S087	1
BOLT (Ref # 92153)	92153-S126	2
WASHER,FINAL DRIVE GEAR (Ref # 92200)	92200-S114	2
WASHER (Ref # 92200A)	92200-S115	1
NUT,CLUTCH HOUSING (Ref # 92210)	92210-S083	1
NUT,SHOE CLUTCH (Ref # 92210A)	92210-S084	1