

2006 KFX50 PARTS DIAGRAM

Crankshaft

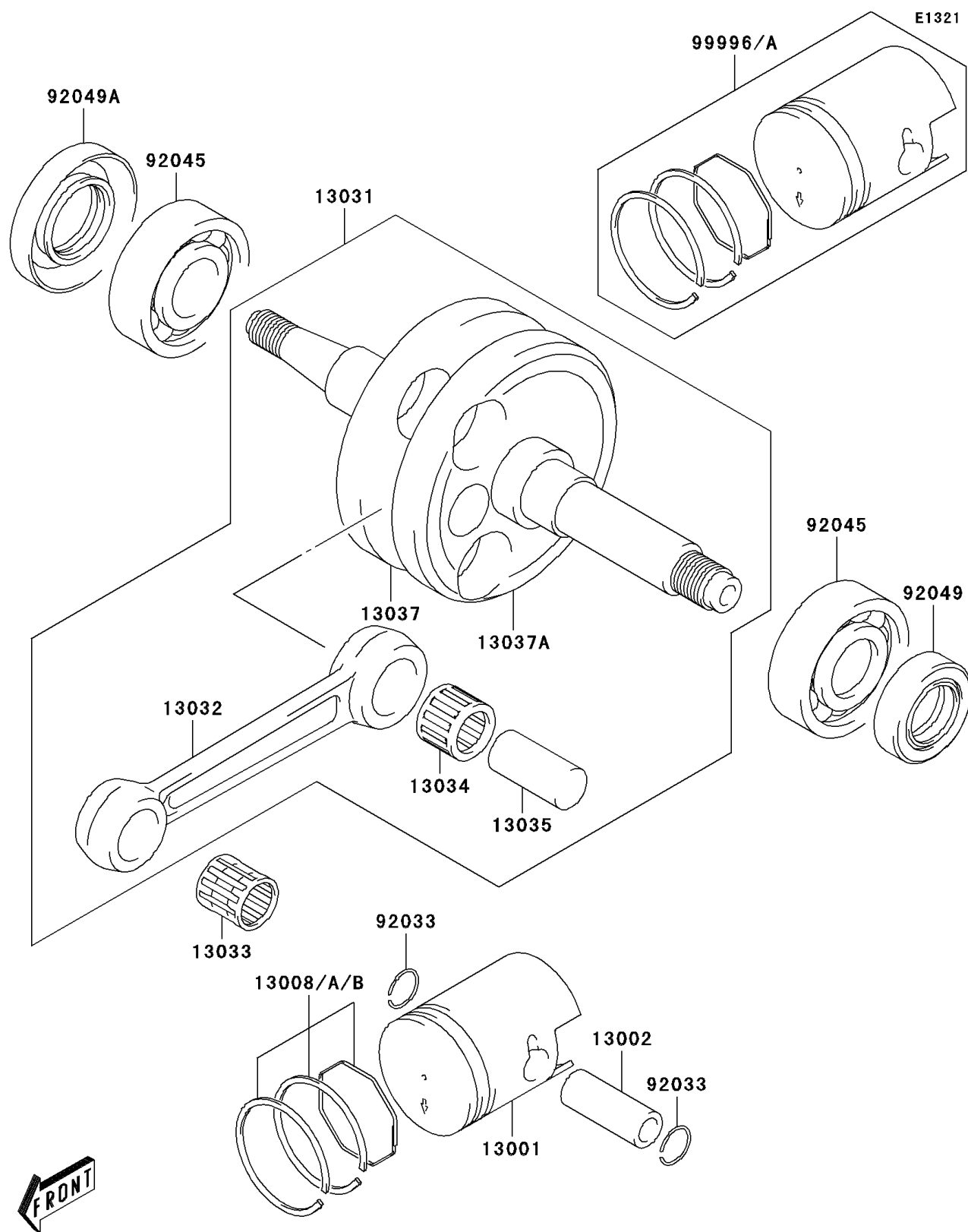

2006 KFX50 PARTS LIST

Crankshaft

ITEM NAME	PART NUMBER	QUANTITY
PISTON-ENGINE (Ref # 13001)	13001-S004	1
PIN-PISTON,PISTON (Ref # 13002)	13002-S004	1
RING-SET-PISTON,STD (Ref # 13008)	13008-S004	1
RING-SET-PISTON,O/S 0.50 (Ref # 13008A)	13008-S009	1
RING-SET-PISTON,O/S 1.00 (Ref # 13008B)	13008-S010	1
CRANKSHAFT-COMP (Ref # 13031)	13031-S004	1
ROD-CONNECTING (Ref # 13032)	13032-S004	1
BEARING-SMALL END (Ref # 13033)	13033-S001	1
BEARING-BIG END (Ref # 13034)	13034-S004	1
PIN-CRANK,CRANK (Ref # 13035)	13035-S004	1
CRANKSHAFT,RH (Ref # 13037)	13037-S007	1
CRANKSHAFT,LH (Ref # 13037A)	13037-S008	1
RING-SNAP,PISTON PIN (Ref # 92033)	92033-S024	1
BEARING-BALL,17X40X12 (Ref # 92045)	92045-S035	1
SEAL-OIL,CRANKSHAFT OIL,LH (Ref # 92049)	92049-S028	1
SEAL-OIL,CRANKSHAFT OIL,RH (Ref # 92049A)	92049-S029	1
PISTON,O/S 0.50 (Ref # 99996)	99996-S008	1
PISTON,O/S 1.00 (Ref # 99996A)	99996-S009	1