

# 2006 KFX400 PARTS DIAGRAM

Crankcase

E1411

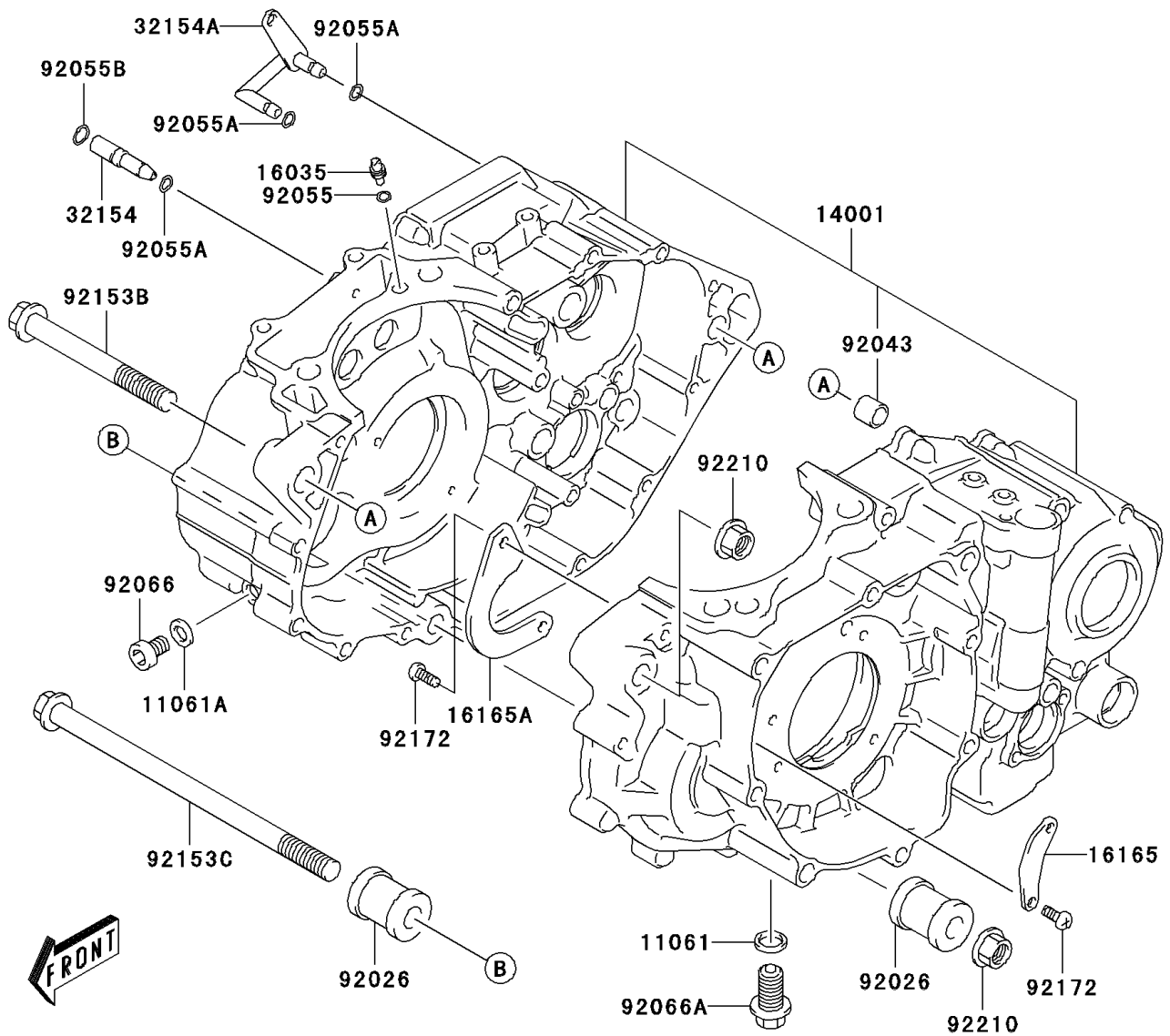
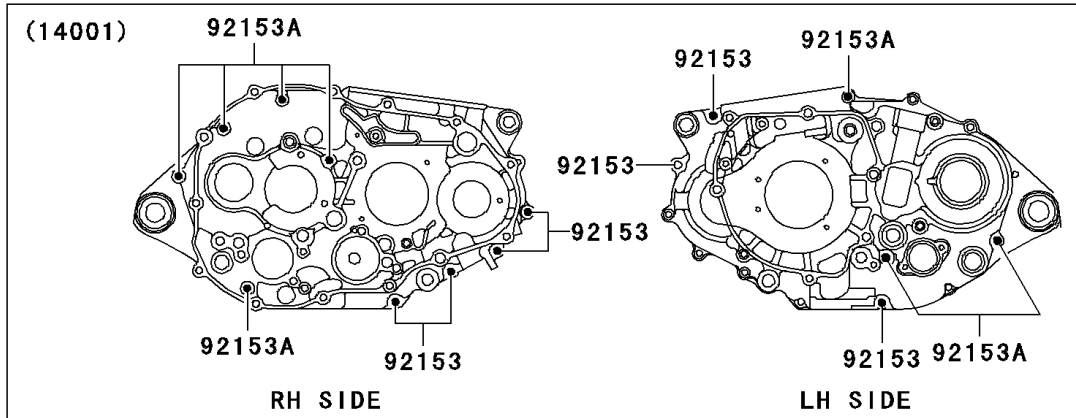

## 2006 KFX400 PARTS LIST

### Crankcase

ITEM NAME	PART NUMBER	QUANTITY
GASKET,12X16X2 (Ref # 11061)	11061-S005	1
GASKET,10X14X3.6 (Ref # 11061A)	11061-S021	1
SET-CRANKCASE (Ref # 14001)	14001-S012	1
JET-AIR (Ref # 16035)	16035-S003	1
SEPARATOR,CRANKCASE OIL (Ref # 16165)	16165-S007	1
SEPARATOR,CRANKCASE OIL (Ref # 16165A)	16165-S008	1
PIPE (Ref # 32154)	32154-S005	1
PIPE (Ref # 32154A)	32154-S006	1
SPACER (Ref # 92026)	92026-S107	2
PIN (Ref # 92043)	92043-S003	2
RING-O,ID=4.0 (Ref # 92055)	92055-S002	1
RING-O,ID:4.8 (Ref # 92055A)	92055-S003	3
RING-O,6.8X1.9 (Ref # 92055B)	92055-S053	1
PLUG (Ref # 92066)	92066-S009	1
PLUG,OIL DRAIN (Ref # 92066A)	92066-S053	1
BOLT (Ref # 92153)	92153-S128	7
BOLT (Ref # 92153A)	92153-S247	8
BOLT,10X100 (Ref # 92153B)	92153-S269	1
BOLT,10X180 (Ref # 92153C)	92153-S270	1
SCREW (Ref # 92172)	92172-S033	4
NUT (Ref # 92210)	92210-S015	2