

# 2003 Mojave 250 PARTS DIAGRAM

Crankshaft

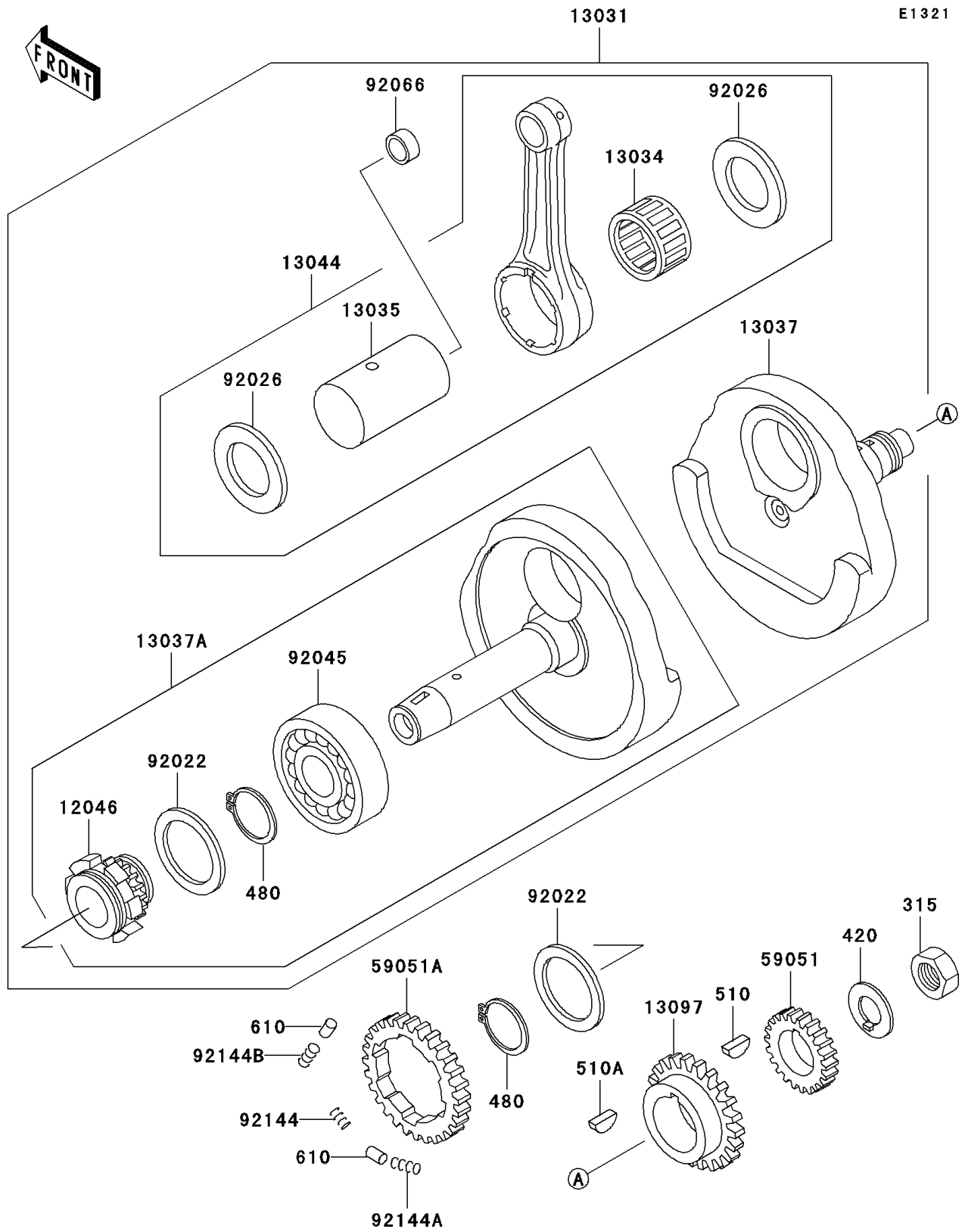

## 2003 Mojave 250 PARTS LIST

### Crankshaft

ITEM NAME	PART NUMBER	QUANTITY
NUT-HEX-FINE,16MM (Ref # 315)	315B1600	1
WASHER-CLAW,16MM (Ref # 420)	420B1611	1
CIRCLIP (Ref # 480)	480J4000	2
KEY-WOODRUFF (Ref # 510)	510A3100	1
KEY-WOODRUFF (Ref # 510A)	510A5100	1
ROLLER (Ref # 610)	610A0510	6
SPROCKET,CAM,21T (Ref # 12046)	12046-1086	1
CRANKSHAFT-COMP (Ref # 13031)	13031-1280	1
BEARING-BIG END (Ref # 13034)	13034-1085	1
PIN-CRANK (Ref # 13035)	13035-1069	1
CRANKSHAFT,RH (Ref # 13037)	13037-1284	1
CRANKSHAFT,LH (Ref # 13037A)	13037-5070	1
SET-CONNECTING ROD (Ref # 13044)	13044-5075	1
GEAR-PRIMARY SPUR,20T (Ref # 13097)	13097-1170	1
GEAR-SPUR,OIL PUMP,18T (Ref # 59051)	59051-1122	1
GEAR-SPUR,BALANCER,39T (Ref # 59051A)	59051-1169	1
WASHER,40.5X60X1.6 (Ref # 92022)	92022-1798	2
SPACER,32.2X51.5X1.2 (Ref # 92026)	92026-1348	2
BEARING-BALL (Ref # 92045)	92045-1172	1
PLUG,TENSIONER (Ref # 92066)	92066-1249	1
SPRING,BALANCER OUTSIDE (Ref # 92144)	92144-1091	1
SPRING,BALANCER,INSIDE (Ref # 92144A)	92144-1092	1
SPRING,BALANCER GEAR (Ref # 92144B)	92144-1248	5