

2003 Mojave 250 PARTS DIAGRAM

Camshaft(s)/Tensioner

E1230

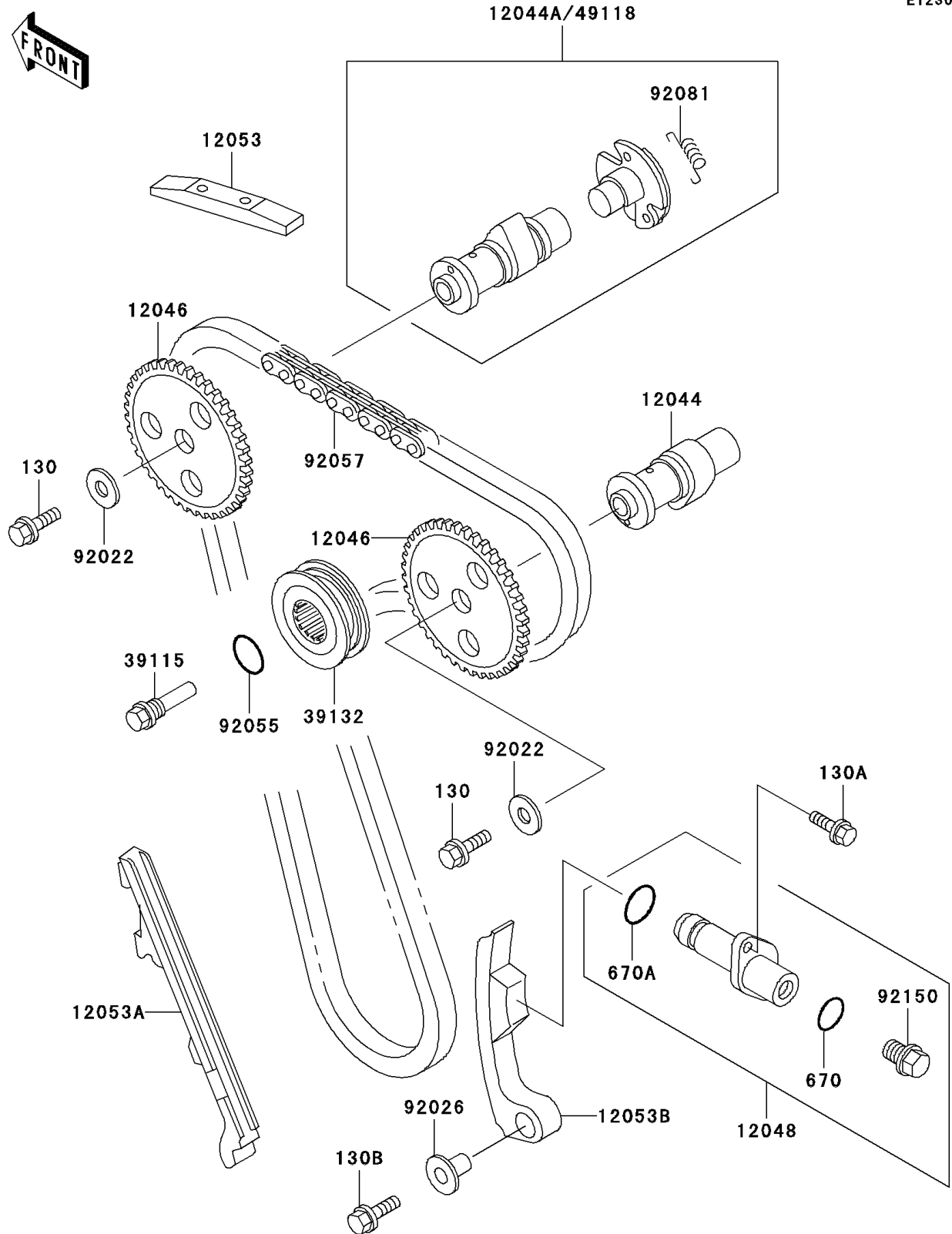

2003 Mojave 250 PARTS LIST

Camshaft(s)/Tensioner

ITEM NAME	PART NUMBER	QUANTITY
BOLT-FLANGED,10X25 (Ref # 130)	130G1025	1
BOLT-FLANGED,6X25 (Ref # 130A)	130J0625	1
BOLT-FLANGED,8X30 (Ref # 130B)	130P0830	1
O RING (Ref # 670)	670D2010	1
O RING,21MM (Ref # 670A)	670D2021	1
CAMSHAFT-VALVE,INTAKE (Ref # 12044)	12044-1348	1
SPROCKET,42T (Ref # 12046)	12046-1063	1
TENSIONER-ASSY,CAM CHAIN (Ref # 12048)	12048-1066	1
GUIDE-CHAIN,UPP (Ref # 12053)	12053-1107	1
GUIDE-CHAIN,FR (Ref # 12053A)	12053-1125	1
GUIDE-CHAIN,RR (Ref # 12053B)	12053-1126	1
SHAFT-IDLER (Ref # 39115)	39115-1051	1
SPROCKET-ASSY-IDLER (Ref # 39132)	39132-1052	1
WASHER,10X22X3 (Ref # 92022)	92022-1365	1
SPACER,L=28.3 (Ref # 92026)	92026-1231	1
RING-O,ID=13.8 (Ref # 92055)	92055-1141	1
CHAIN,CAM,79RH2010-158L (Ref # 92057)	92057-1170	1
SPRING,DECOMPRESSOR (Ref # 92081)	92081-1626	1
BOLT,TENSIONER (Ref # 92150)	92150-1380	1
CAMSHAFT-VALVE,EXHAUST (Ref # 12044A)	12044-1427	1
CAMSHAFT-COMP,EXHAUST (Ref # 49118)	49118-1168	1