

1997 Mojave 250

PARTS DIAGRAM

Crankcase

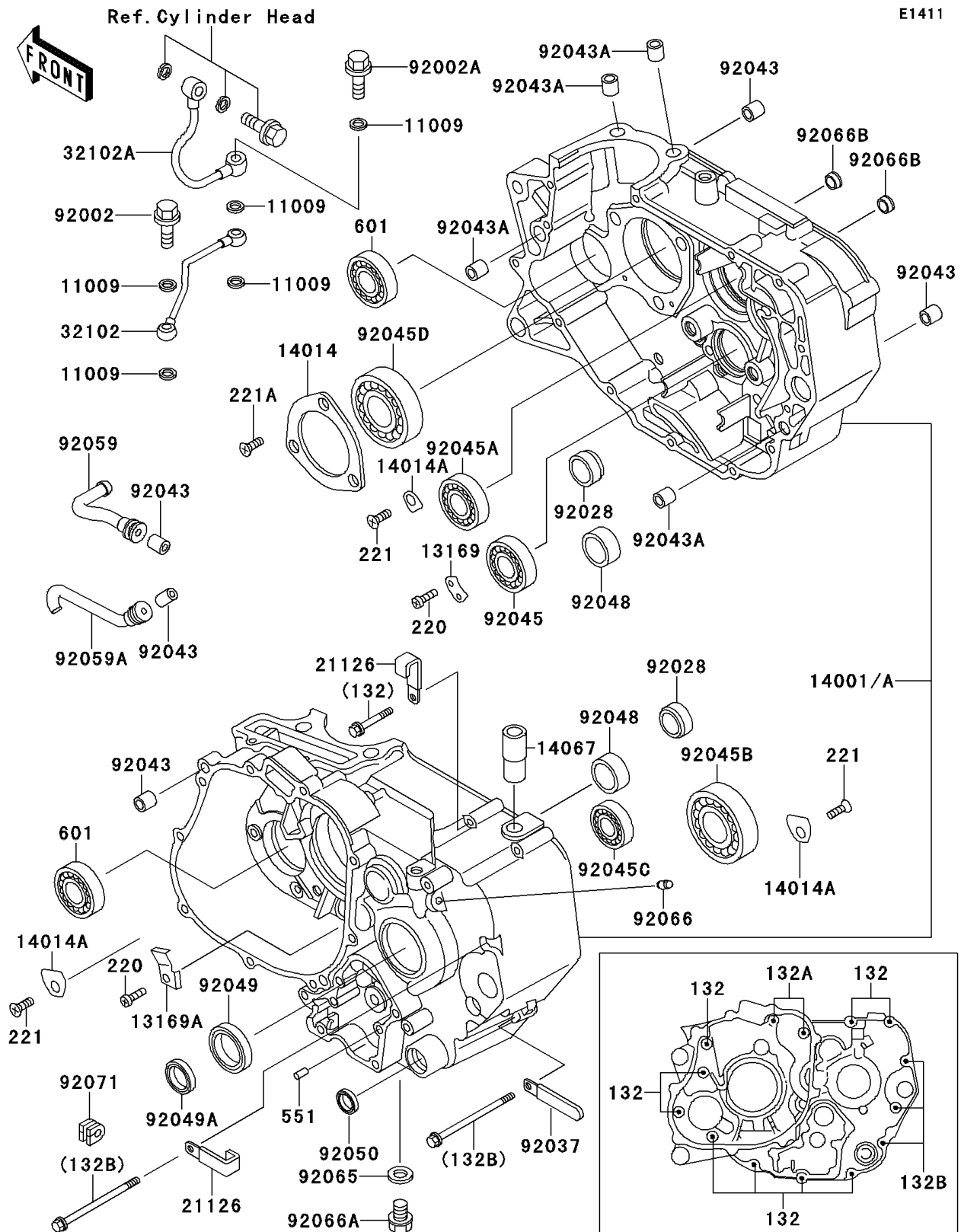

1997 Mojave 250

PARTS LIST

Crankcase

ITEM NAME	PART NUMBER	QUANTITY
BOLT-FLANGED-SMALL,6X40 (Ref # 132)	132J0640	9
BOLT-FLANGED-SMALL (Ref # 132A)	132J0675	2
BOLT-FLANGED-SMALL (Ref # 132B)	132J0695	3
SCREW-PAN-CROS,6X14 (Ref # 220)	220B0614	3
SCREW-CSK-CROS,6X12 (Ref # 221)	221B0612	3
SCREW-CSK-CROS,6X16 (Ref # 221A)	221B0616	3
PIN-DOWEL,6X12 (Ref # 551)	551A0612	2
GASKET,10X14.5X1.5 (Ref # 11009)	11009-1105	5
PLATE,GEAR CHANGE DRUM (Ref # 13169)	13169-014	1
PLATE (Ref # 13169A)	13169-1691	1
SET-CRANKCASE (Ref # 14001A)	14001-5354	1
PLATE-POSITION,CRANK BEARING (Ref # 14014)	14014-1004	1
PLATE-POSITION (Ref # 14014A)	14014-1057	3
FITTING,BREATHER (Ref # 14067)	14067-006	1
CLAMP,WIRING HARNESS (Ref # 21126)	21126-008	2
PIPE (Ref # 32102)	32102-1127	1
PIPE (Ref # 32102A)	32102-1187	1
BOLT,BANJO,10X25 (Ref # 92002)	92002-1170	1
BOLT,BANJO,10X36.5 (Ref # 92002A)	92002-1751	1
BUSHING,23X30X13 (Ref # 92028)	92028-132	2
CLAMP,L=45 (Ref # 92037)	92037-1539	1
PIN,6.2X8X14 (Ref # 92043)	92043-1263	6
PIN,10.1X12X14 (Ref # 92043A)	92043-4009	4
BEARING-BALL,#6905 (Ref # 92045)	92045-036	1
BEARING-BALL,TMB204 JR (Ref # 92045A)	92045-1041	1
BEARING-BALL,TM-SX0597LU (Ref # 92045B)	92045-1127	1
BEARING-BALL,6804 (Ref # 92045C)	92045-1171	1
BEARING-BALL (Ref # 92045D)	92045-1172	1
RACE,26X33X13 (Ref # 92048)	92048-1057	2

1997 Mojave 250

PARTS LIST

Crankcase

ITEM NAME	PART NUMBER	QUANTITY
SEAL-OIL,TC32457 (Ref # 92049)	92049-1159	1
SEAL-OIL,SD20307HS (Ref # 92049A)	92049-1261	1
SEAL-OIL (Ref # 92050)	92050-082	1
TUBE (Ref # 92059)	92059-1694	1
TUBE (Ref # 92059A)	92059-1695	1
GASKET,12X22X2,DRAIN PLUG (Ref # 92065)	92065-097	1
PLUG,OIL DRAIN,12X15 (Ref # 92066A)	92066-1174	1
PLUG (Ref # 92066B)	92066-1282	2
GROMMET (Ref # 92071)	92071-1139	1
BEARING-BALL,#6204 (Ref # 601)	601A6204	2