

## 2014 Z250SL PARTS DIAGRAM

Oil Pump

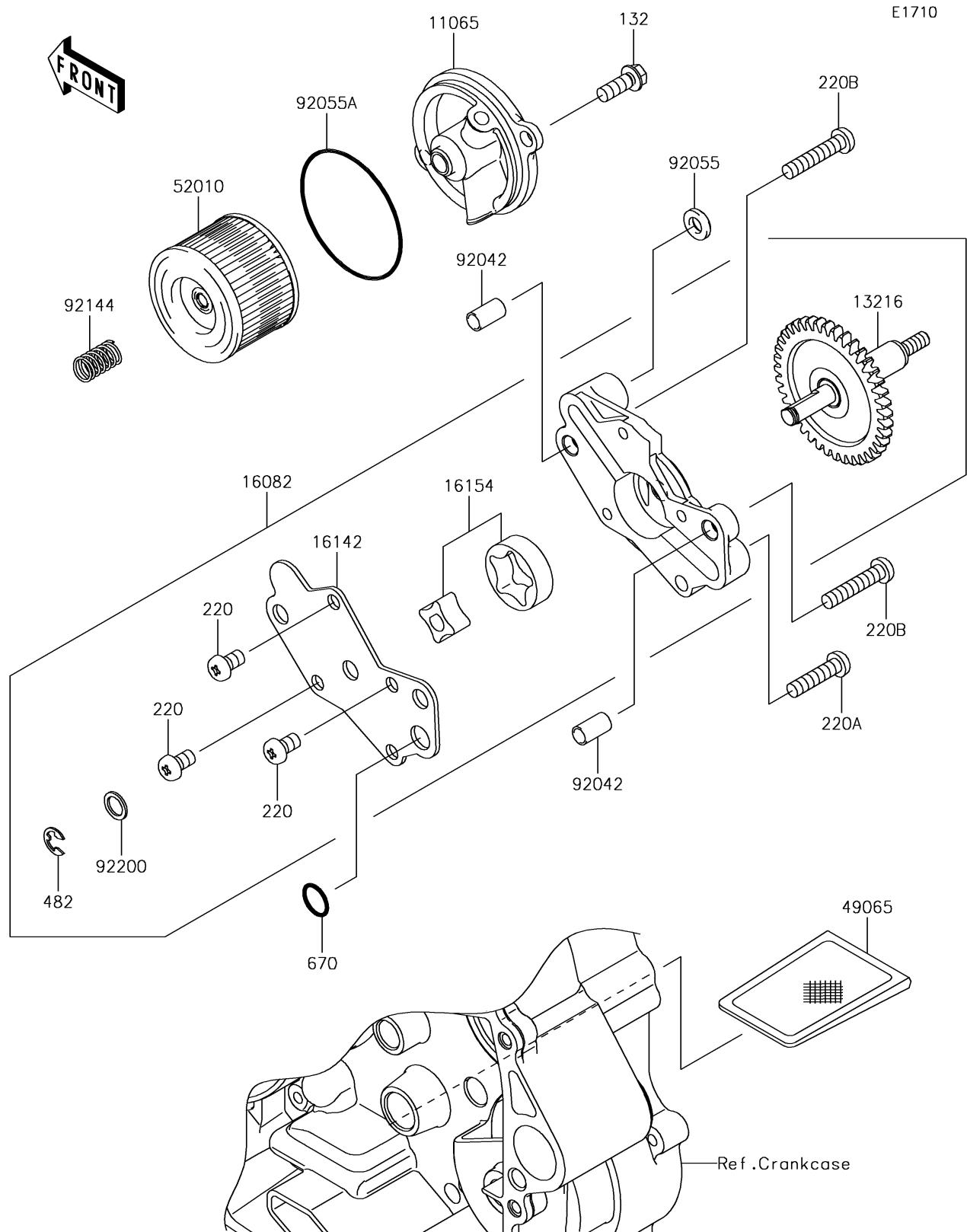

## 2014 Z250SL PARTS LIST

### Oil Pump

ITEM NAME	PART NUMBER	QUANTITY
CAP,OIL FILTER (Ref # 11065)	11065-0833	1
BOLT-FLANGED-SMALL,6X16 (Ref # 132)	132BB0616	1
GEAR-COMP,OIL PUMP (Ref # 13216)	13216-0878	1
PUMP-ASSY-OIL (Ref # 16082)	16082-0727	1
COVER-PUMP (Ref # 16142)	16142-0713	1
ROTOR-PUMP (Ref # 16154)	16154-0714	1
SCREW-PAN-CROS,6X10 (Ref # 220)	220AA0610	1
SCREW-PAN-CROS,6X25 (Ref # 220A)	220AA0625	1
SCREW-PAN-CROS,6X30 (Ref # 220B)	220AA0630	1
CIRCLIP-TYPE-E,6MM (Ref # 482)	482J6000	1
FILTER-OIL (Ref # 49065)	49065-1058	1
ELEMENT-OIL FILTER (Ref # 52010)	52010-1053	1
O RING,10MM (Ref # 670)	670D2010	1
PIN,DOWEL,6.3X8X14 (Ref # 92042)	92042-007	1
RING-O,OD=13 (Ref # 92055)	92055-074	1
RING-O,52.6X2.4 (Ref # 92055A)	92055-1577	1
SPRING (Ref # 92144)	92144-1761	1
WASHER,8.5X12X1 (Ref # 92200)	92200-0890	1