

2018 NINJA® ZX™-10R ABS PARTS DIAGRAM

Gear Change Drum/Shift Fork(s)

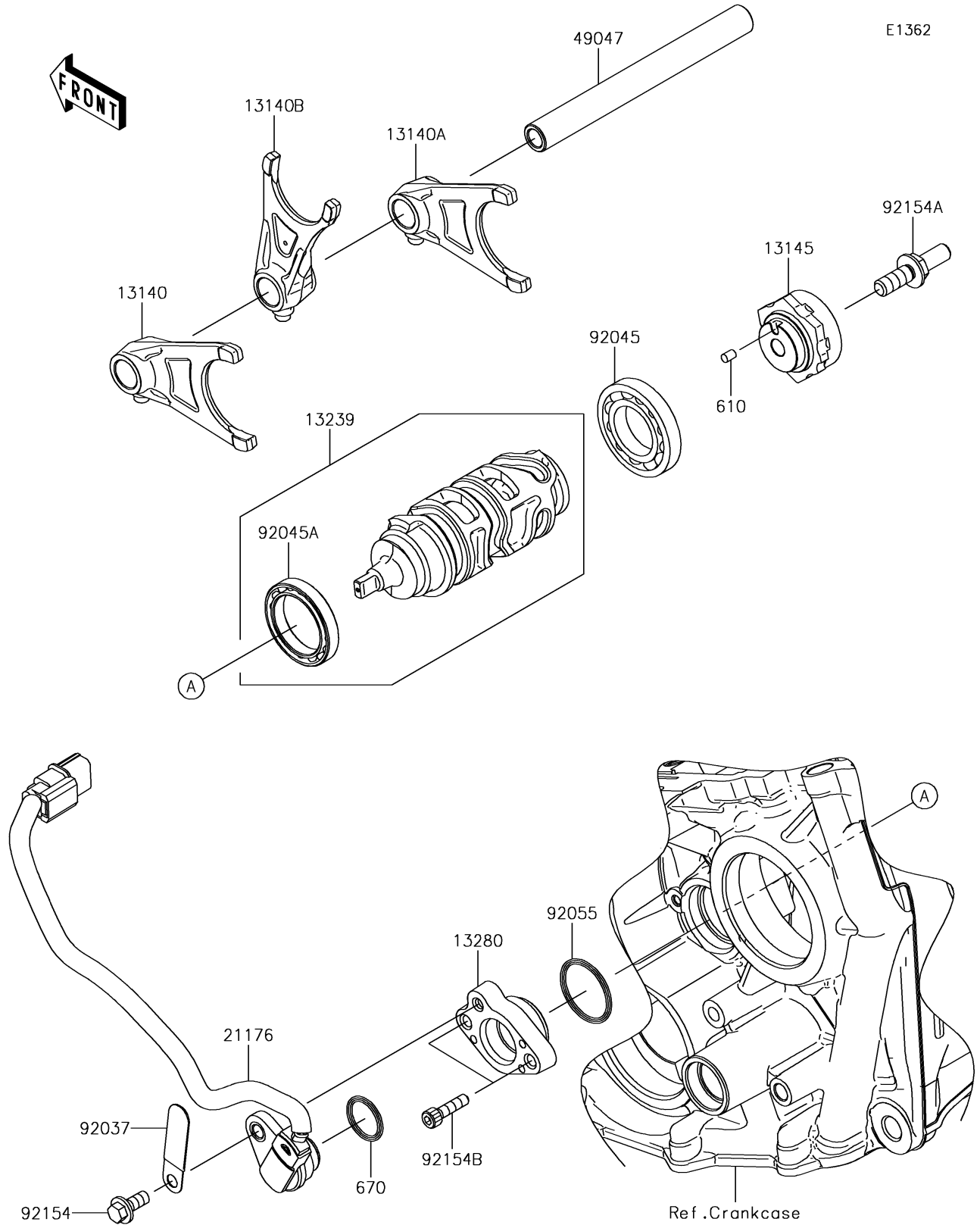

2018 NINJA® ZX™-10R ABS PARTS LIST

Gear Change Drum/Shift Fork(s)

ITEM NAME	PART NUMBER	QUANTITY
FORK-SHIFT,OUTPUT,LH (Ref # 13140)	13140-0064	1
FORK-SHIFT,OUTPUT,RH (Ref # 13140A)	13140-0065	1
FORK-SHIFT,INPUT,CNT (Ref # 13140B)	13140-0650	1
CAM-CHANGE DRUM (Ref # 13145)	13145-0051	1
DRUM-ASSY-CHANGE (Ref # 13239)	13239-0041	1
HOLDER,GEAR POSITION SENSOR (Ref # 13280)	13280-0846	1
SENSOR,GEAR POSITION (Ref # 21176)	21176-0820	1
ROD-SHIFT (Ref # 49047)	49047-0623	1
ROLLER,4X6 (Ref # 610)	610A0406	1
O RING,18MM (Ref # 670)	670D2018	1
CLAMP,L=45 (Ref # 92037)	92037-1539	1
BEARING-BALL,16005 (Ref # 92045)	92045-1045	1
BEARING-BALL,6806 (Ref # 92045A)	92045-1152	1
RING-O,27.7X2.4 (Ref # 92055)	92055-091	1
BOLT,FLANGED,6X14 (Ref # 92154)	92154-1797	1
BOLT (Ref # 92154A)	92154-1883	1
BOLT,SOCKET,5X20 (Ref # 92154B)	92154-2084	1