

## 2014 VERSYS® 1000 (European) PARTS DIAGRAM

Crankcase Bolt Pattern

E1412

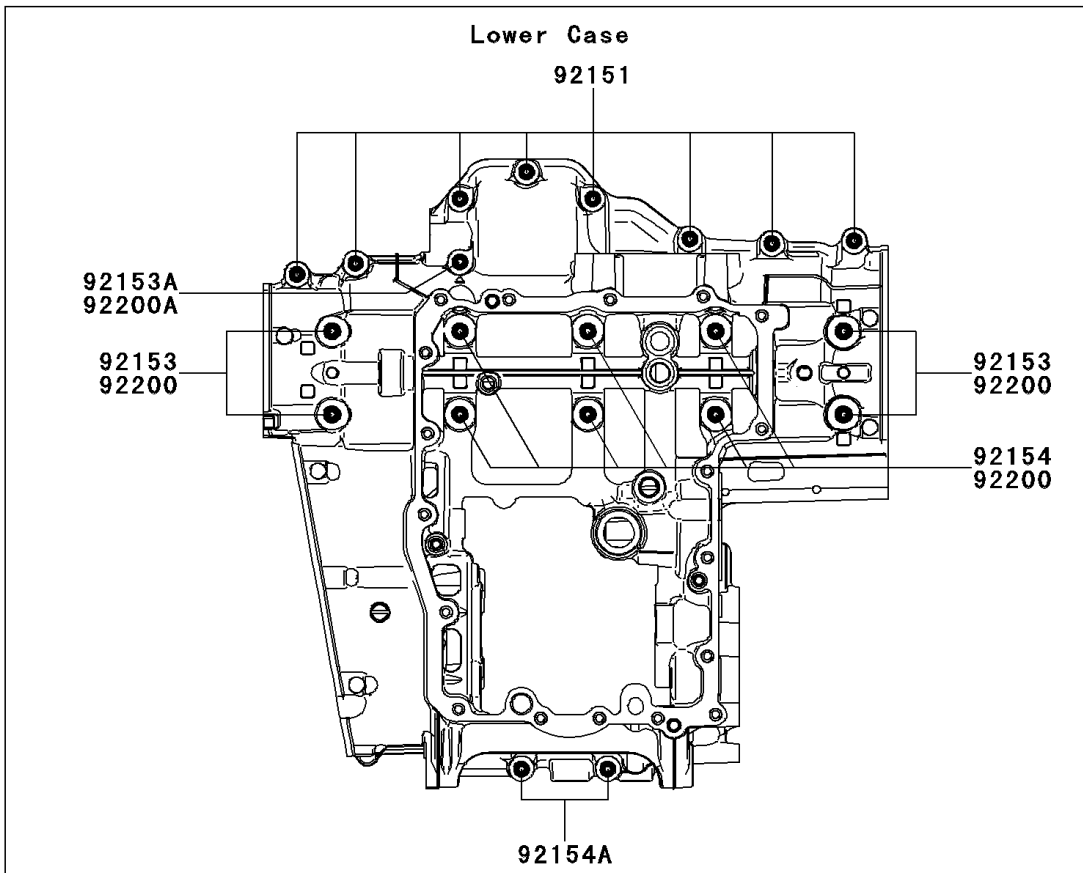
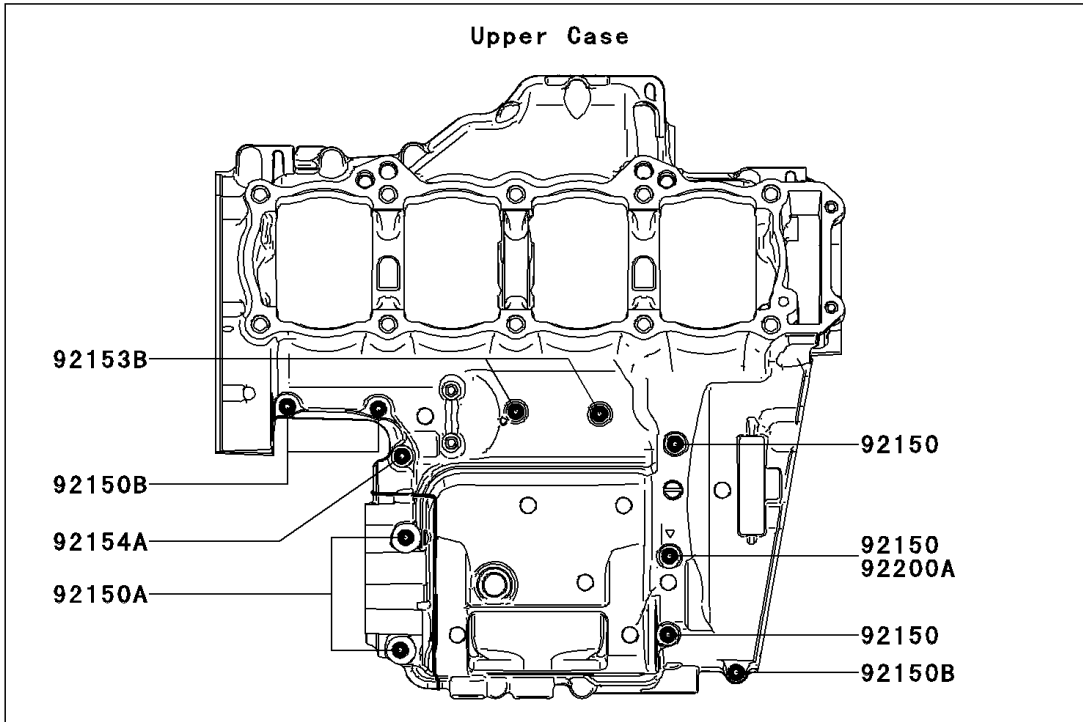

## 2014 VERSYS® 1000 (European) PARTS LIST

Crankcase Bolt Pattern

ITEM NAME	PART NUMBER	QUANTITY
BOLT,FLANGED,7X85 (Ref # 92150)	92150-1251	1
BOLT,8X70 (Ref # 92150A)	92150-1483	1
BOLT,6X40 (Ref # 92150B)	92150-1794	1
BOLT,FLANGED,7X45 (Ref # 92151)	92151-1539	1
BOLT,FLANGED,9X100 (Ref # 92153)	92153-0447	1
BOLT,FLANGED,7X60 (Ref # 92153A)	92153-1045	1
BOLT,FLANGED,6X68 (Ref # 92153B)	92153-1637	1
BOLT,FLANGED,9X90 (Ref # 92154)	92154-0248	1
BOLT,FLANGED,7X50 (Ref # 92154A)	92154-0372	1
WASHER,9.2X19X2.3 (Ref # 92200)	92200-0115	1
WASHER (Ref # 92200A)	92200-0556	1