

1996 KLX650 PARTS DIAGRAM

Chassis Electrical Equipment

F2760

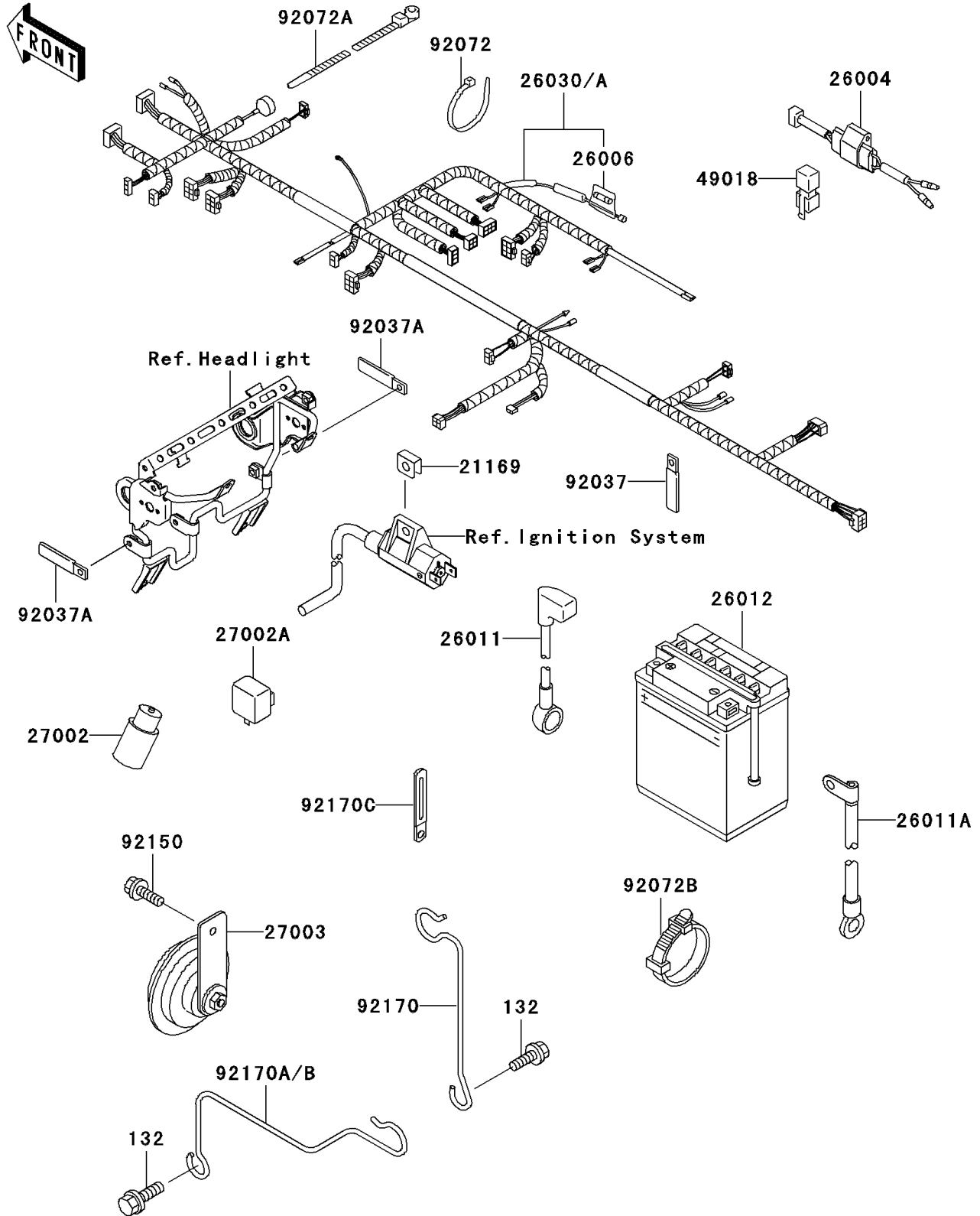

1996 KLX650 PARTS LIST

Chassis Electrical Equipment

ITEM NAME	PART NUMBER	QUANTITY
BOLT-FLANGED-SMALL (Ref # 132)	132G0612	2
TERMINAL (Ref # 21169)	21169-1066	1
FUSE-ASSY (Ref # 26004)	26004-1089	1
FUSE,10A,L=30 (Ref # 26006)	26006-1002	3
WIRE-LEAD,BATTERY(+) (Ref # 26011)	26011-1546	1
WIRE-LEAD,BATTERY(-) (Ref # 26011A)	26011-1548	1
BATTERY,YTX9-BS,12V 8AH (Ref # 26012)	26012-1282	1
HARNESS,MAIN (Ref # 26030A)	26030-1221	1
RELAY-ASSY (Ref # 27002)	27002-1051	2
RELAY-ASSY,TURN SIGNAL (Ref # 27002A)	27002-1053	1
HORN (Ref # 27003)	27003-1288	1
DIODE (Ref # 49018)	49018-1058	1
CLAMP (Ref # 92037)	92037-1679	1
CLAMP (Ref # 92037A)	92037-1993	2
BAND,L=250 (Ref # 92072)	92072-1237	4
BAND,L=215 (Ref # 92072A)	92072-1288	1
BAND,L=140 (Ref # 92072B)	92072-1293	4
BOLT,6X14 (Ref # 92150)	92150-1340	1
CLAMP,HARNESS (Ref # 92170)	92170-1359	1
CLAMP,HARNESS (Ref # 92170B)	92170-1428	1
CLAMP,CARBURETOR HOSE (Ref # 92170C)	92170-1514	1