

1996 KLX650 PARTS DIAGRAM

Generator

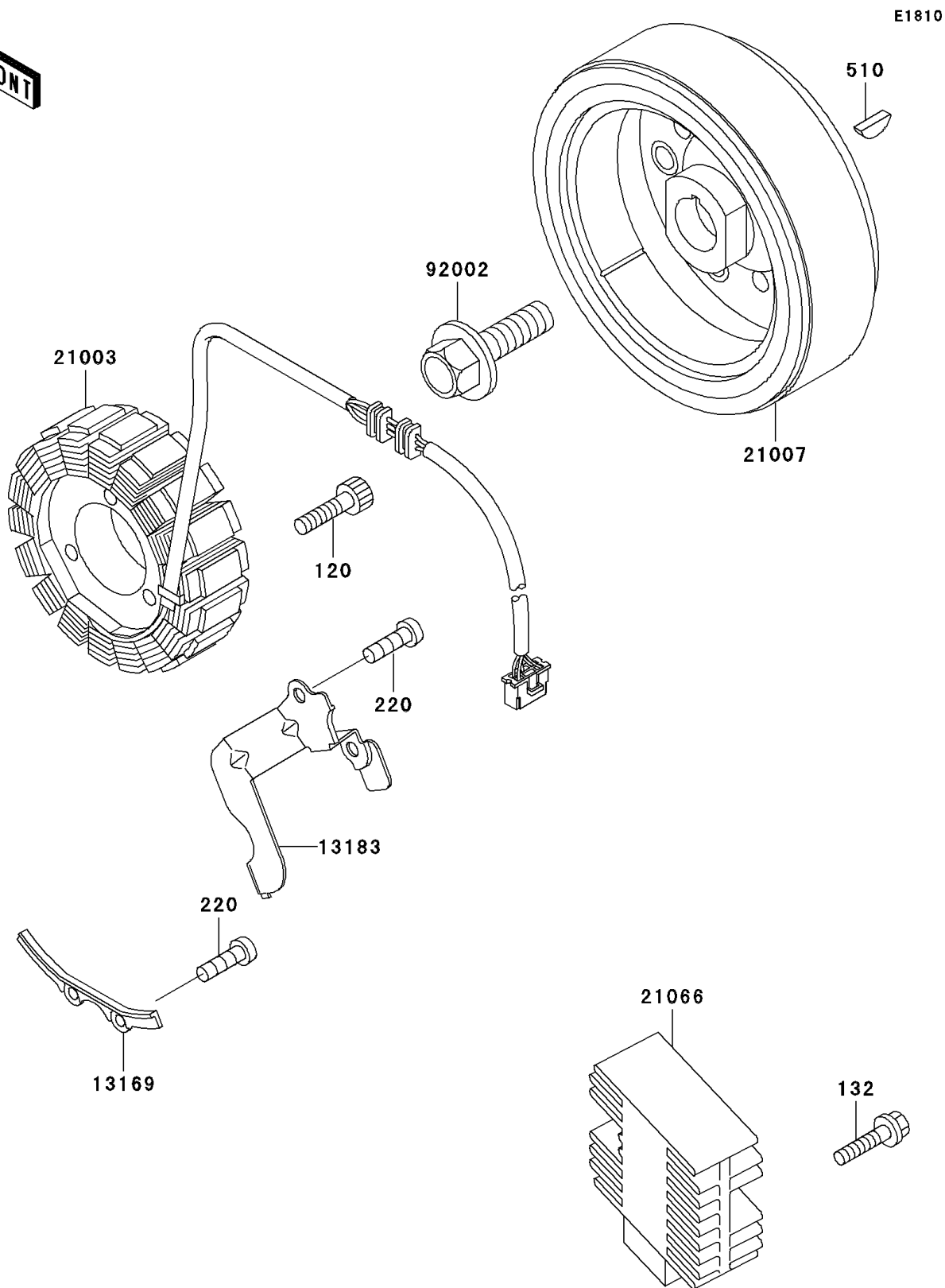

1996 KLX650 PARTS LIST

Generator

ITEM NAME	PART NUMBER	QUANTITY
BOLT-SOCKET,6X30 (Ref # 120)	120P0630	1
BOLT-FLANGED-SMALL (Ref # 132)	132J0625	1
SCREW-PAN-CROS,5X8 (Ref # 220)	220B0508	1
KEY-WOODRUFF (Ref # 510)	510A4200	1
PLATE,PULSING COIL LEAD (Ref # 13169)	13169-1882	1
PLATE,LEAD WIRE (Ref # 13183)	13183-1989	1
STATOR (Ref # 21003)	21003-1255	1
ROTOR,MAGNETO (Ref # 21007)	21007-1255	1
REGULATOR-VOLTAGE (Ref # 21066)	21066-1091	1
BOLT,FLANGED,12X40 (Ref # 92002)	92002-1693	1