

2010 Ninja® ZX™-6R PARTS DIAGRAM

Oil Pump/Oil Filter

E1710

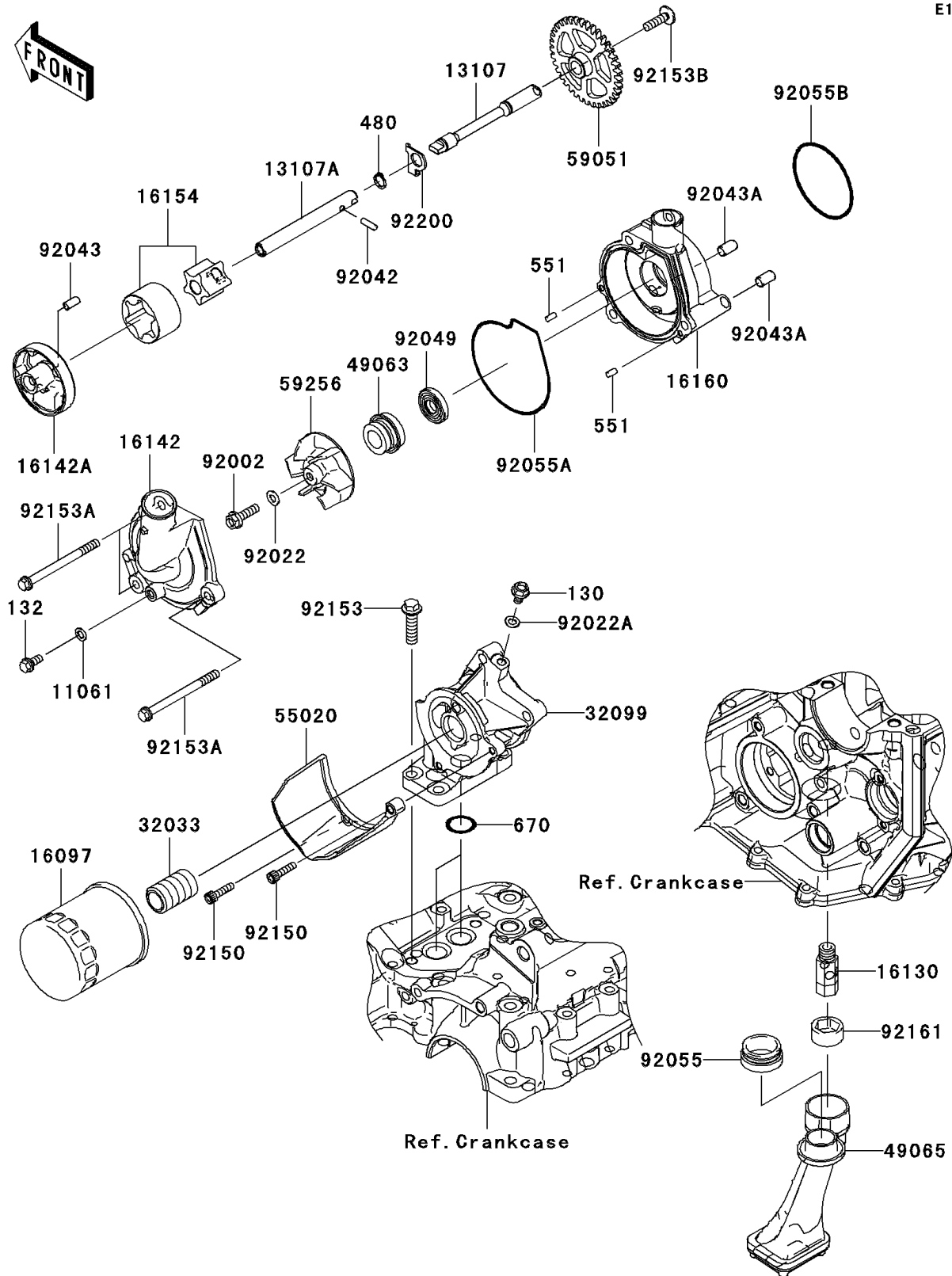

2010 Ninja® ZX™-6R PARTS LIST

Oil Pump/Oil Filter

ITEM NAME	PART NUMBER	QUANTITY
GASKET (Ref # 11061)	11061-0107	1
BOLT-FLANGED,6X10 (Ref # 130)	130BD0610	1
SHAFT,PUMP,RH (Ref # 13107)	13107-0132	1
SHAFT,LH (Ref # 13107A)	13107-0202	1
BOLT-FLANGED-SMALL,6X12 (Ref # 132)	132BA0612	1
FILTER-ASSY-OIL (Ref # 16097)	16097-0004	1
VALVE-ASSY-RELIEF (Ref # 16130)	16130-1059	1
COVER-PUMP,WATER (Ref # 16142)	16142-0050	1
COVER-PUMP (Ref # 16142A)	16142-0057	1
ROTOR-PUMP (Ref # 16154)	16154-0057	1
BODY,WATER PUMP (Ref # 16160)	16160-0140	1
PIPE,OIL FILTER (Ref # 32033)	32033-1535	1
CASE,OIL FILTER&COOLER (Ref # 32099)	32099-0035	1
CIRCLIP-TYPE-C,11MM (Ref # 480)	480J1100	1
SEAL-MECHANICAL,WATER (Ref # 49063)	49063-1055	1
FILTER-OIL (Ref # 49065)	49065-0024	1
GUARD,OIL FILTER (Ref # 55020)	55020-0358	1
PIN-DOWEL,4X8 (Ref # 551)	551A0408	1
GEAR-SPUR,37T (Ref # 59051)	59051-0092	1
IMPELLER (Ref # 59256)	59256-1074	1
O RING (Ref # 670)	670D2018	1
BOLT,6X22 (Ref # 92002)	92002-1154	1
WASHER,6.1X12X1 (Ref # 92022)	92022-077	1
WASHER,6.2X11X1 (Ref # 92022A)	92022-304	1
PIN,DOWEL,4X13.8 (Ref # 92042)	92042-030	1
PIN,4.2X6X12 (Ref # 92043)	92043-1262	1
PIN,6.2X8X14 (Ref # 92043A)	92043-1263	1
SEAL-OIL,SC 11 28.55 5 (Ref # 92049)	92049-1336	1
RING-O,OIL FILTER (Ref # 92055)	92055-1503	1

2010 Ninja® ZX™-6R PARTS LIST

Oil Pump/Oil Filter

ITEM NAME	PART NUMBER	QUANTITY
RING-O,WATER PUMP COVER (Ref # 92055A)	92055-1532	1
RING-O,59.6X2.4 (Ref # 92055B)	92055-3018	1
BOLT,SOCKET,5X20 (Ref # 92150)	92150-1019	1
BOLT,FLANGED,8X30 (Ref # 92153)	92153-1086	1
BOLT,FLANGED,6X75 (Ref # 92153A)	92153-1649	1
BOLT,SOCKET,6X22 (Ref # 92153B)	92153-1792	1
DAMPER (Ref # 92161)	92161-0070	1
WASHER (Ref # 92200)	92200-0317	1