

# 1997 KLX300R PARTS DIAGRAM

Rear Brake

F2294

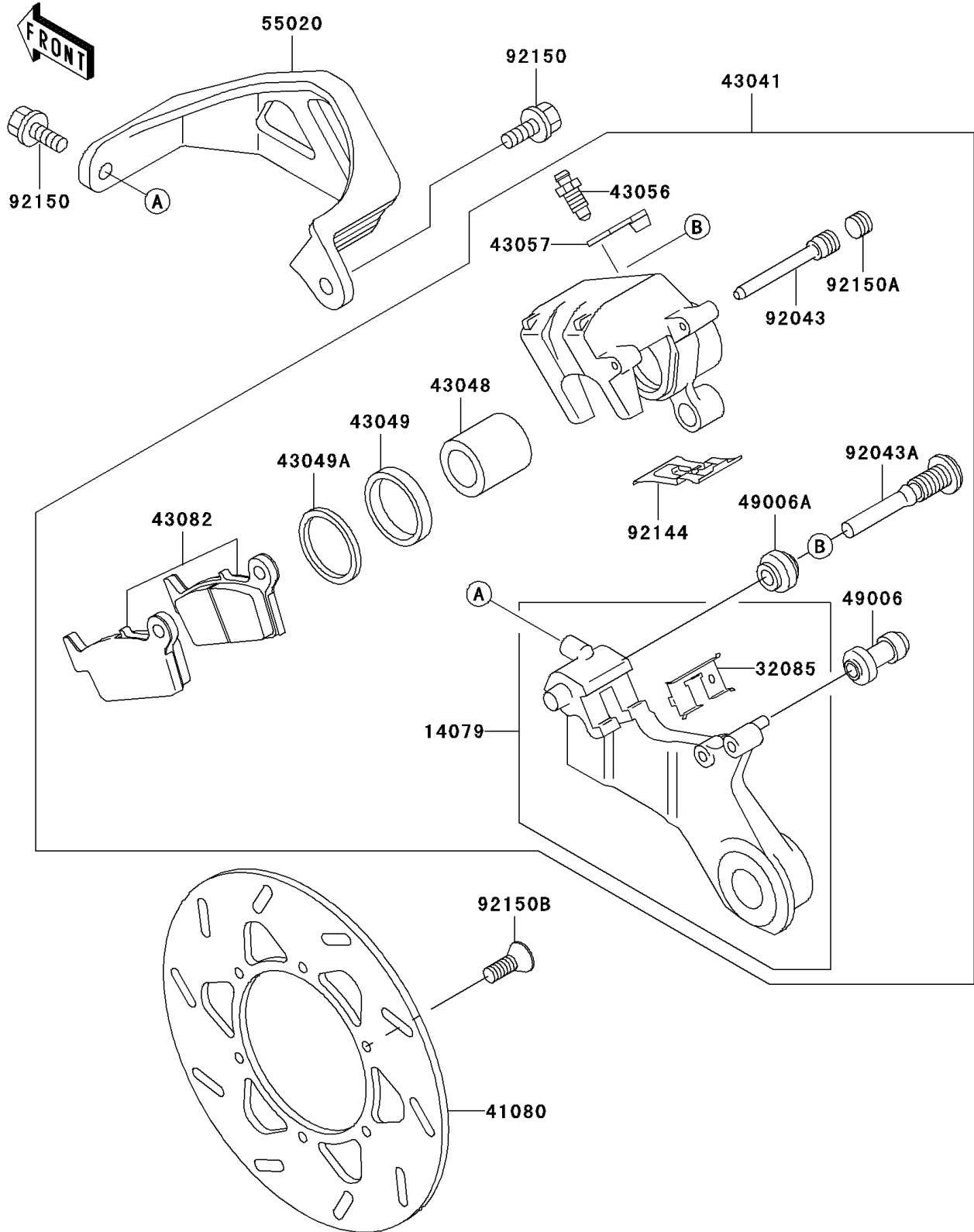

# 1997 KLX300R PARTS LIST

## Rear Brake

| ITEM NAME                              | PART NUMBER   | QUANTITY |
|--|---------------|----------|
| HOLDER-ASSY,REAR CALIPER (Ref # 14079) | 14079-1105    | 1        |
| STOPPER,PAD (Ref # 32085)              | 32085-1386    | 1        |
| DISC,RR (Ref # 41080)                  | 41080-1384    | 1        |
| CALIPER-ASSY,RR (Ref # 43041)          | 43041-1577    | 1        |
| PISTON-CALIPER (Ref # 43048)           | 43048-1068    | 1        |
| PACKING,PISTON SEAL (Ref # 43049)      | 43049-1060    | 1        |
| PACKING,PISTON SEAL (Ref # 43049A)     | 43049-1061    | 1        |
| BREATHER-BRAKE (Ref # 43056)           | 43056-1055    | 1        |
| CAP-BREATHER (Ref # 43057)             | 43057-1001    | 1        |
| PAD-ASSY-BRAKE (Ref # 43082)           | 43082-1173    | 1        |
| BOOT,CALIPER (Ref # 49006)             | 49006-1088    | 1        |
| BOOT,CALIPER (Ref # 49006A)            | 49006-1242    | 1        |
| GUARD,RR CALIPER,P.WHITE (Ref # 55020) | 55020-1488-6F | 1        |
| PIN,HANGER (Ref # 92043)               | 92043-1507    | 1        |
| PIN (Ref # 92043A)                     | 92043-1508    | 1        |
| SPRING,PAD (Ref # 92144)               | 92144-1819    | 1        |
| BOLT,6X14 (Ref # 92150)                | 92150-1340    | 2        |
| BOLT,PLUG (Ref # 92150A)               | 92150-1692    | 1        |
| BOLT,DISC PLATE,8X15 (Ref # 92150B)    | 92150-1811    | 6        |