

2000 KLX300R PARTS DIAGRAM

Swingarm

F2141

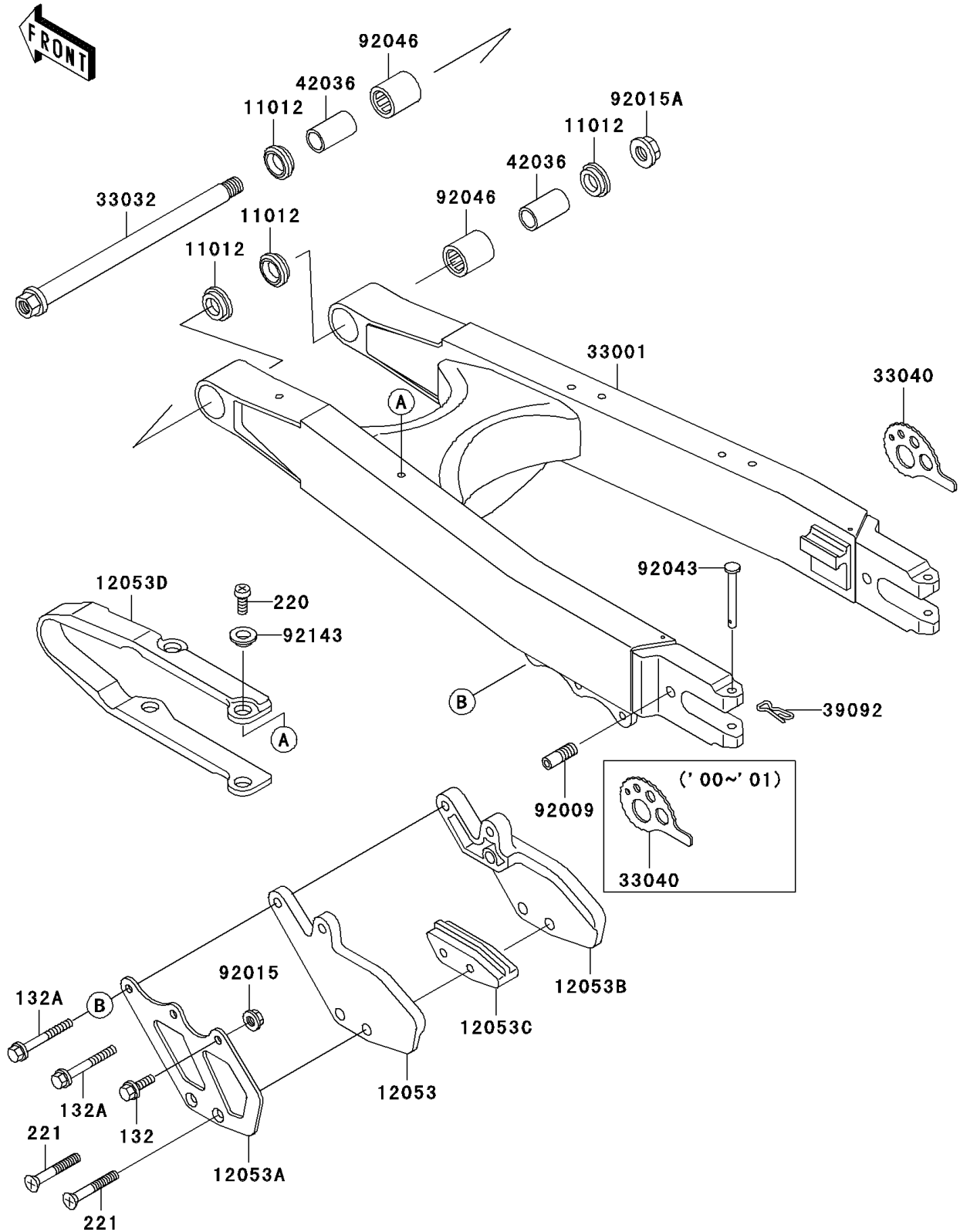

2000 KLX300R PARTS LIST

Swingarm

ITEM NAME	PART NUMBER	QUANTITY
BOLT-FLANGED-SMALL (Ref # 132)	132G0616	1
BOLT-FLANGED-SMALL (Ref # 132A)	132G0635	2
SCREW-PAN-CROS,6X8 (Ref # 220)	220B0608	4
SCREW-CSK-CROS,6X45 (Ref # 221)	221B0645	2
CAP,SWING ARM (Ref # 11012)	11012-1259	4
GUIDE-CHAIN,RR,INSIDE (Ref # 12053)	12053-1234	1
GUIDE-CHAIN,RR,OUTSIDE (Ref # 12053A)	12053-1235	1
GUIDE-CHAIN,RR,OUTSIDE (Ref # 12053B)	12053-1236	1
GUIDE-CHAIN,DRIVE,RR,INSIDE (Ref # 12053C)	12053-1270	1
GUIDE-CHAIN,DRIVE,FR (Ref # 12053D)	12053-1328	1
ARM-COMP-SWING,SILVER (Ref # 33001)	33001-1508-CE	1
SHAFT-SWING ARM (Ref # 33032)	33032-1137	1
ADJUSTER-CHAIN (Ref # 33040)	33040-1113	2
PIN-HAIR (Ref # 39092)	39092-1057	2
SLEEVE,SWING ARM (Ref # 42036)	42036-1064	2
SCREW,SET,10X29 (Ref # 92009)	92009-1686	2
NUT,FLANGED,6MM (Ref # 92015)	92015-1078	1
NUT,14MM (Ref # 92015A)	92015-1407	1
PIN,6X45 (Ref # 92043)	92043-1590	2
BEARING-NEEDLE,TA2030Z (Ref # 92046)	92046-1128	2
COLLAR (Ref # 92143)	92143-1156	4