

2000 KLX300R PARTS DIAGRAM

Muffler(s)

E1140

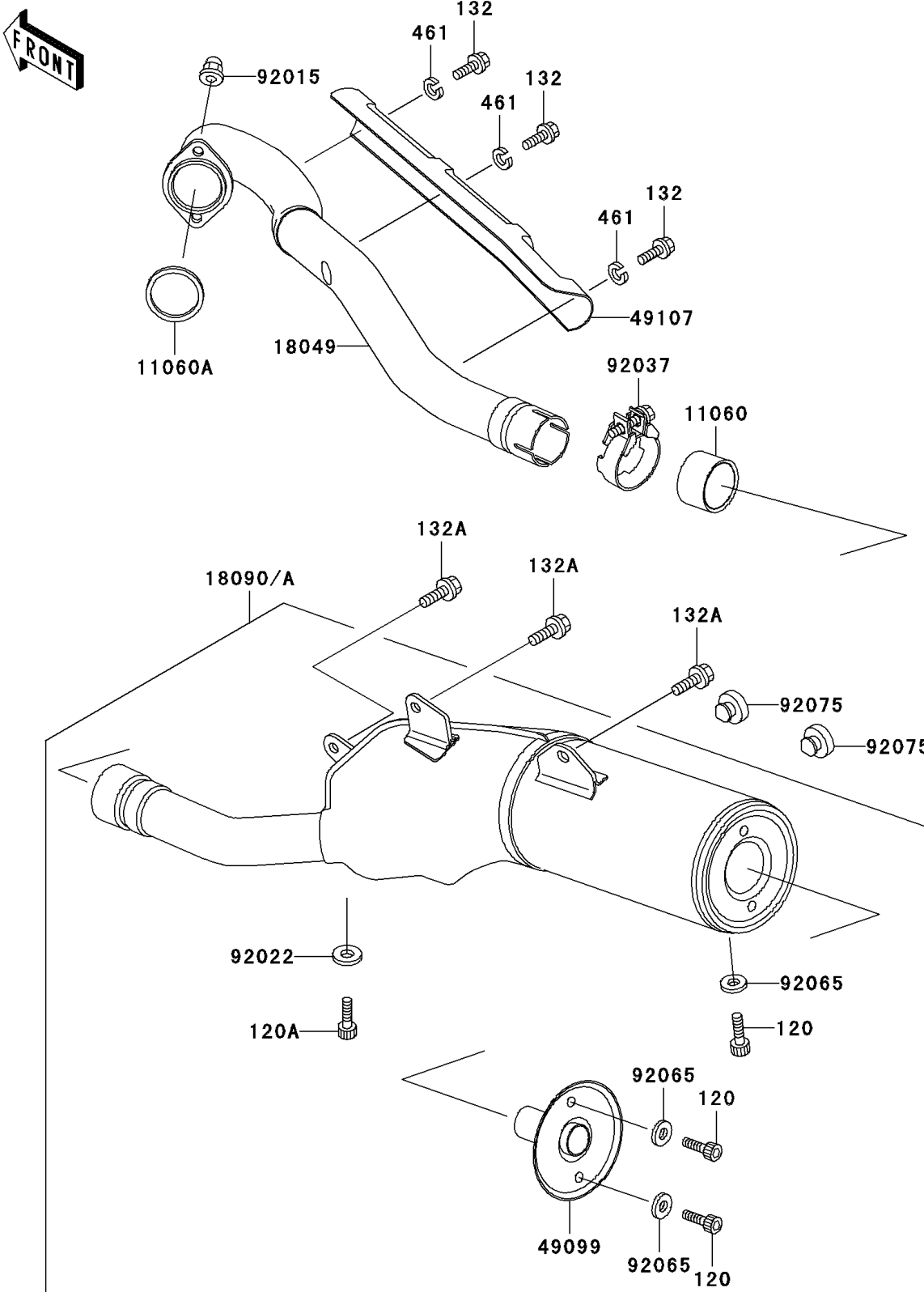

2000 KLX300R PARTS LIST

Muffler(s)

ITEM NAME	PART NUMBER	QUANTITY
BOLT-FLANGED-SMALL (Ref # 132)	132Y0608	3
BOLT-FLANGED-SMALL (Ref # 132A)	132Y0816	3
WASHER-SPRING,6MM (Ref # 461)	461S0600	3
GASKET,MANIFOLD EXHAUST (Ref # 11060)	11060-1068	1
GASKET,EXHAUST PIPE (Ref # 11060A)	11060-1203	1
PIPE-EXHAUST (Ref # 18049)	18049-1689	1
COVER-EXHAUST PIPE (Ref # 49107)	49107-1095	1
NUT,8MM (Ref # 92015)	92015-1402	2
CLAMP,MUFFLER,BLACK (Ref # 92037)	92037-1270	1
DAMPER (Ref # 92075)	92075-005	2
BOLT-SOCKET,6X12 (Ref # 120)	120P0612	3
BOLT-SOCKET,8X14 (Ref # 120A)	120P0814	1
BODY-COMP-MUFFLER (Ref # 18090)	18090-1569	1
BODY-COMP-MUFFLER (Ref # 18090A)	18090-1570	1
BAFFLE-PIPE MUFFLER (Ref # 49099)	49099-1541	1
WASHER,8.2X14X1.0 (Ref # 92022)	92022-1488	1
GASKET (Ref # 92065)	92065-096	3