

2002 KLX110 PARTS DIAGRAM

Engine Mount

F2122

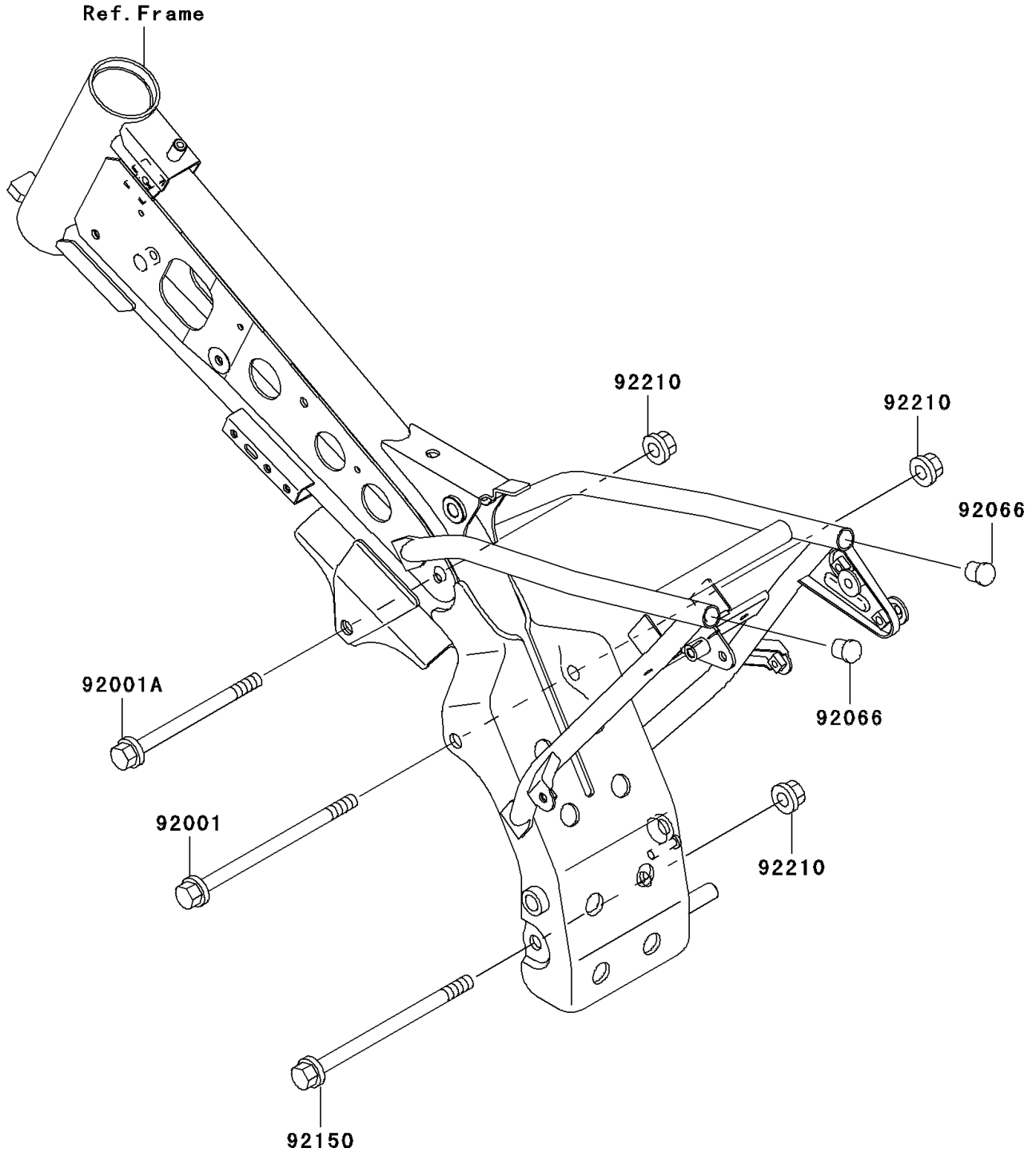

2002 KLX110 PARTS LIST

Engine Mount

ITEM NAME	PART NUMBER	QUANTITY
BOLT,FLANGED,10X125 (Ref # 92001)	92001-1720	1
BOLT,FLANGED,10X105,BLACK (Ref # 92001A)	92001-1751	1
PLUG,HEAD LAMP (Ref # 92066)	92066-1081	2
BOLT,FLANGED,10X120 (Ref # 92150)	92150-1831	1
NUT,LOCK,FLANGED,10MM (Ref # 92210)	92210-1081	3