

1999 Bayou 400 4X4 PARTS DIAGRAM

Front Brake

F2292

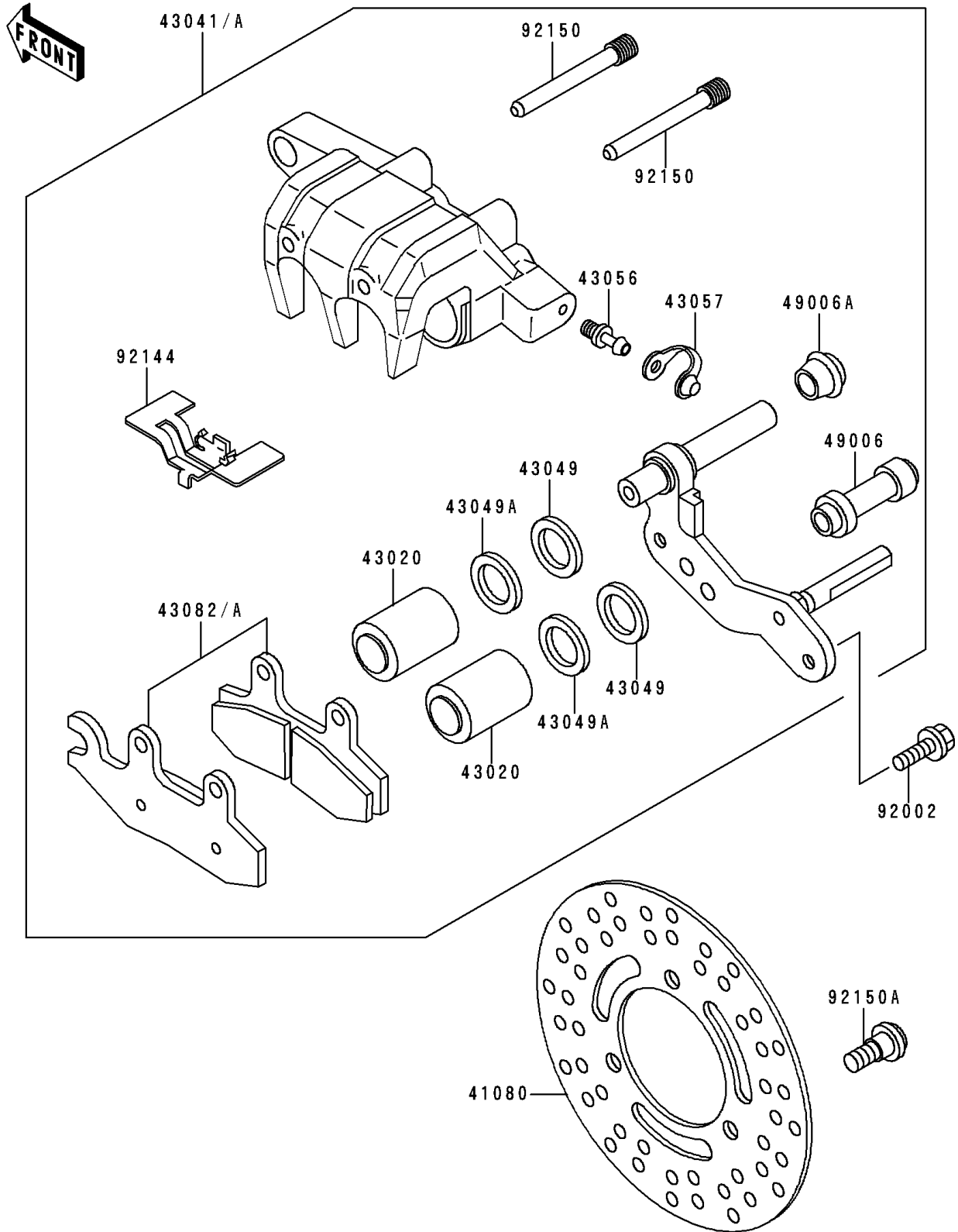

1999 Bayou 400 4X4 PARTS LIST

Front Brake

ITEM NAME	PART NUMBER	QUANTITY
DISC,FR (Ref # 41080)	41080-1216	2
PISTON-COMP-BRAKE (Ref # 43020)	43020-1101	4
CALIPER-ASSY,FR,LH (Ref # 43041)	43041-1518	1
CALIPER-ASSY,FR,RH (Ref # 43041A)	43041-1519	1
PACKING (Ref # 43049)	43049-1063	4
PACKING (Ref # 43049A)	43049-1064	4
BREATHER-BRAKE (Ref # 43056)	43056-1055	2
CAP-BREATHER (Ref # 43057)	43057-1001	2
PAD-ASSY-BRAKE,FR,LH (Ref # 43082)	43082-1093	1
PAD-ASSY-BRAKE,FR,RH (Ref # 43082A)	43082-1094	1
BOOT,CALIPER (Ref # 49006)	49006-1088	2
BOOT,CALIPER (Ref # 49006A)	49006-1242	2
BOLT,FLANGED,8X13 (Ref # 92002)	92002-1737	4
SPRING,PAD (Ref # 92144)	92144-1319	2
BOLT (Ref # 92150)	92150-1144	4
BOLT,SOCKET,8X20 (Ref # 92150A)	92150-1760	6