

1994 Bayou 300 4X4 PARTS DIAGRAM

Optional Parts(Radiator)

F2890

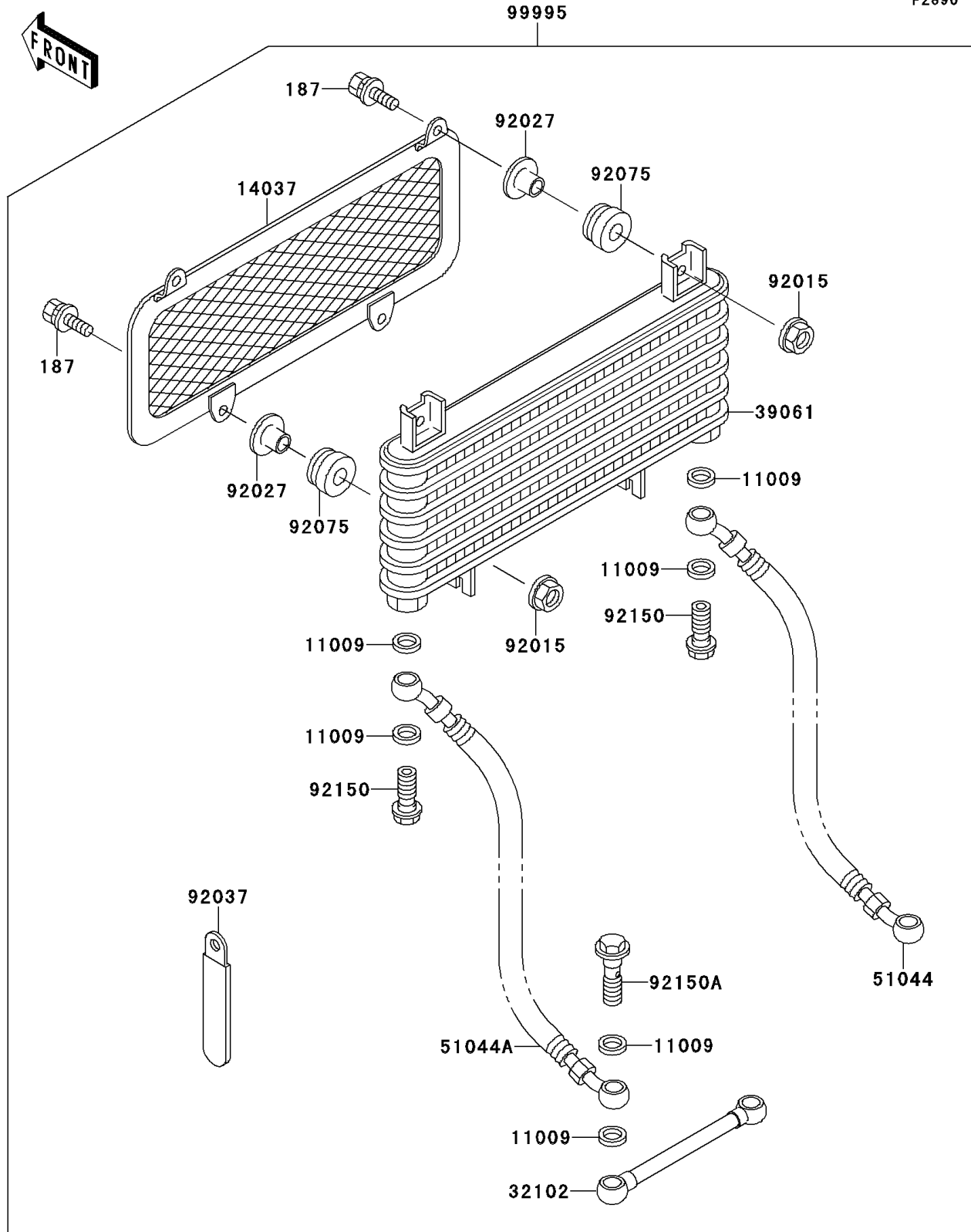

1994 Bayou 300 4X4 PARTS LIST

Optional Parts(Radiator)

ITEM NAME	PART NUMBER	QUANTITY
BOLT-UPSET-WSP (Ref # 187)	187D0625	1
GASKET,10X14.5X1.5 (Ref # 11009)	11009-1105	1
SCREEN (Ref # 14037)	14037-1105	1
PIPE (Ref # 32102)	32102-1966	1
RADIATOR-ASSY (Ref # 39061)	39061-1126	1
TUBE-ASSY (Ref # 51044)	51044-1096	1
TUBE-ASSY (Ref # 51044A)	51044-1097	1
NUT,FLANGED,6MM (Ref # 92015)	92015-1367	1
COLLAR (Ref # 92027)	92027-1767	1
CLAMP (Ref # 92037)	92037-1679	1
DAMPER (Ref # 92075)	92075-277	1
BOLT,BANJO,10X23 (Ref # 92150)	92150-1123	1
BOLT (Ref # 92150A)	92150-1136	1
KIT.,RADIATOR (Ref # 99995)	99995-1022	1