

# 2004 Bayou 300 4X4 PARTS DIAGRAM

Labels

F2860

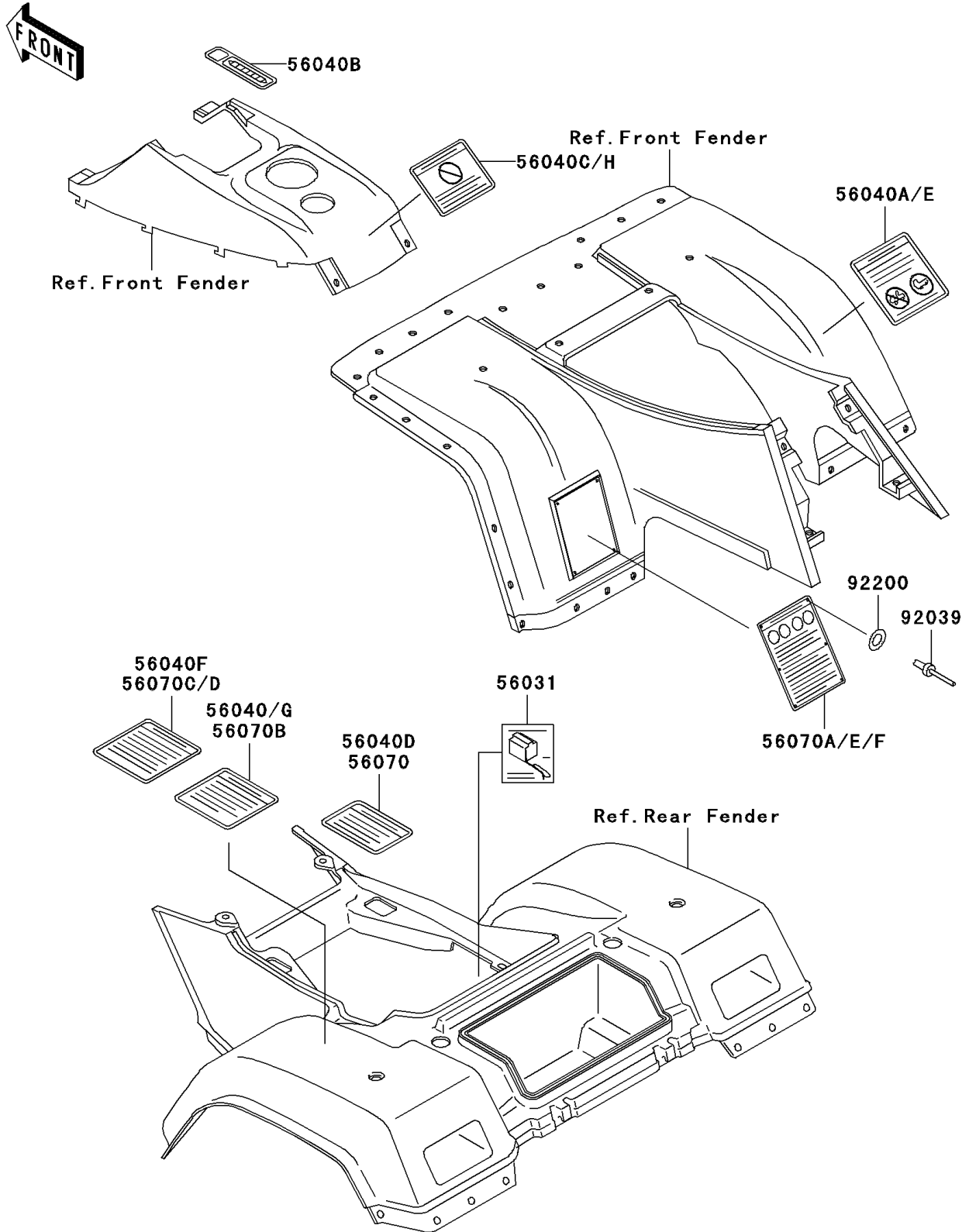

## 2004 Bayou 300 4X4 PARTS LIST

### Labels

ITEM NAME	PART NUMBER	QUANTITY
LABEL-MANUAL,BATTERY VENT (Ref # 56031)	56031-1607	1
LABEL-WARNING,MAXIMUM LOAD (Ref # 56040)	56040-1258	1
LABEL-WARNING,TRANSPORT (Ref # 56040A)	56040-1261	1
LABEL-WARNING,SHIFT PATTERN (Ref # 56040B)	56040-1262	1
LABEL-WARNING,UNDER 16 (Ref # 56040C)	56040-1276	1
LABEL-WARNING,TIRE PRESSURE (Ref # 56070D)	56070-1080	1
LABEL-WARNING,SERIOUS INJURY (Ref # 56070E)	56070-1151	1
RIVET,3.2X8 (Ref # 92039)	92039-3763	6
WASHER,3.5X8X1 (Ref # 92200)	92200-1251	6
LABEL-WARNING,NO PASSENGER (Ref # 56040D)	56040-1280	1
LABEL-WARNING,TRANSPORT (Ref # 56040E)	56040-1283	1
LABEL-WARNING,TIRE PRESSURE (Ref # 56040F)	56040-1286	1
LABEL-WARNING,LOAD CAPACITY (Ref # 56040G)	56040-1287	1
LABEL-WARNING,AGE (Ref # 56040H)	56040-1325	1
LABEL-WARNING,GENERAL (Ref # 56070F)	56070-1163	1