

2002 Bayou 300 4X4 PARTS DIAGRAM

Front Suspension

F2152

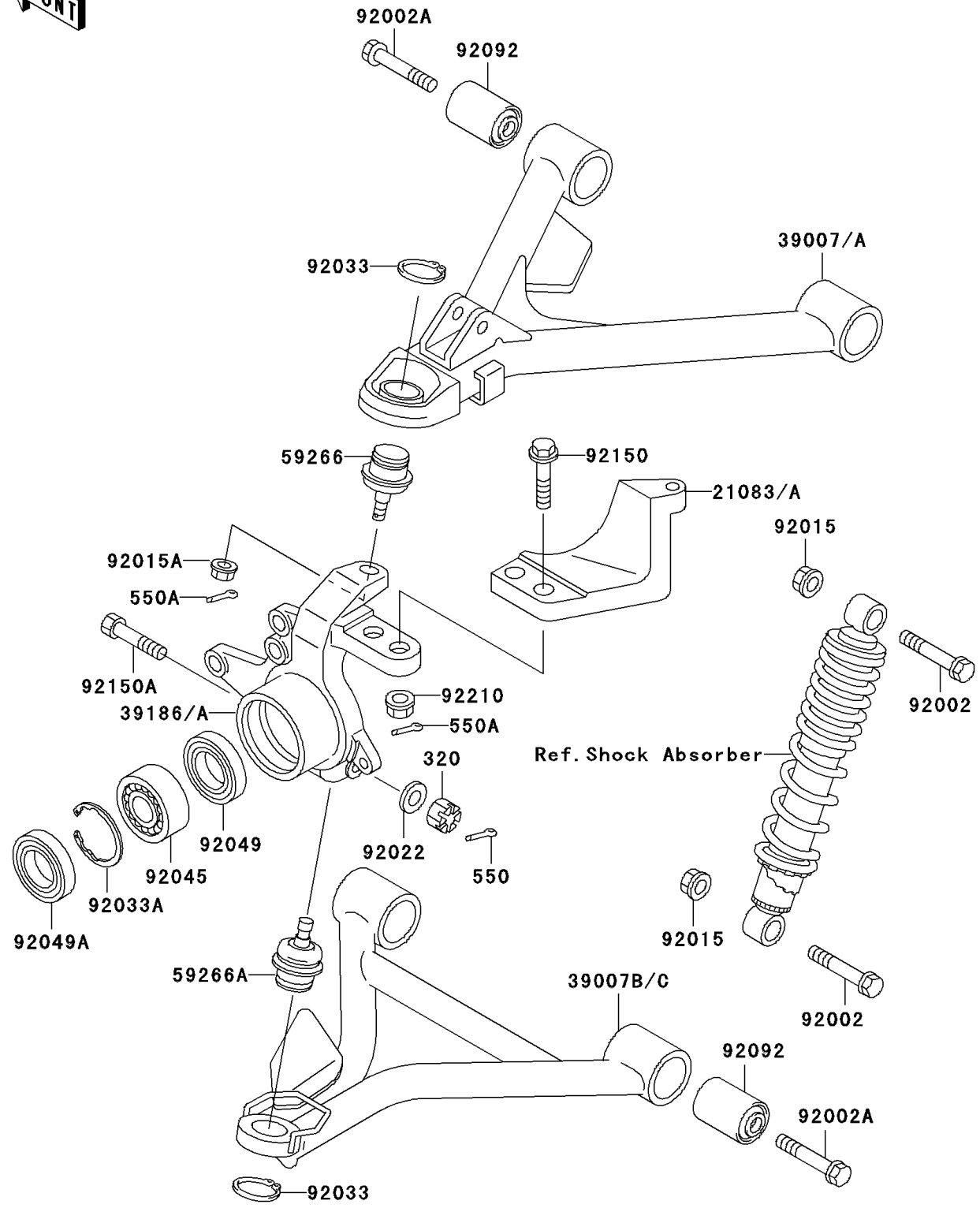

2002 Bayou 300 4X4 PARTS LIST

Front Suspension

ITEM NAME	PART NUMBER	QUANTITY
NUT-CASTLE (Ref # 320)	320H1000	2
PIN-COTTER,2.0X15 (Ref # 550)	550D2015	2
PIN-COTTER,2.5X18 (Ref # 550A)	550D2518	6
ARM,FR,LH (Ref # 21083)	21083-1074	1
ARM,FR,RH (Ref # 21083A)	21083-1075	1
ARM-SUSP,FR,LH,UPP (Ref # 39007)	39007-1159	1
ARM-SUSP,FR,RH,UPP (Ref # 39007A)	39007-1160	1
ARM-SUSP,FR,LH,LWR (Ref # 39007B)	39007-1246	1
ARM-SUSP,FR,RH,LWR (Ref # 39007C)	39007-1247	1
KNUCKLE,FR,LH (Ref # 39186)	39186-1098	1
KNUCKLE,FR,RH (Ref # 39186A)	39186-1099	1
JOINT-BALL (Ref # 59266)	59266-1075	2
JOINT-BALL (Ref # 59266A)	59266-1098	2
BOLT,FLANGED,10X46 (Ref # 92002)	92002-1740	4
BOLT,FLANGED,12X67 (Ref # 92002A)	92002-1861	8
NUT,LOCK,10MM (Ref # 92015)	92015-1597	4
NUT,LOCK,FLANGED,10MM (Ref # 92015A)	92015-1717	2
WASHER,10.2X16X1 (Ref # 92022)	92022-1829	2
RING-SNAP,30MM (Ref # 92033)	92033-1218	4
RING-SNAP,55MM (Ref # 92033A)	92033-1274	2
BEARING-BALL,DAC3055C2RKCD3 (Ref # 92045)	92045-1222	2
SEAL-OIL,MT038N1 (Ref # 92049)	92049-1476	2
SEAL-OIL,SDD04 38 55 8 (Ref # 92049A)	92049-1477	2
BUSHING-RUBBER (Ref # 92092)	92092-1065	8
BOLT,FLANGED,10X42 (Ref # 92150)	92150-1215	4
BOLT,10X44 (Ref # 92150A)	92150-1226	2
NUT,LOCK,10MM (Ref # 92210)	92210-1204	4