

1992 Bayou 300 PARTS DIAGRAM

Rear Fender(s)

F2172

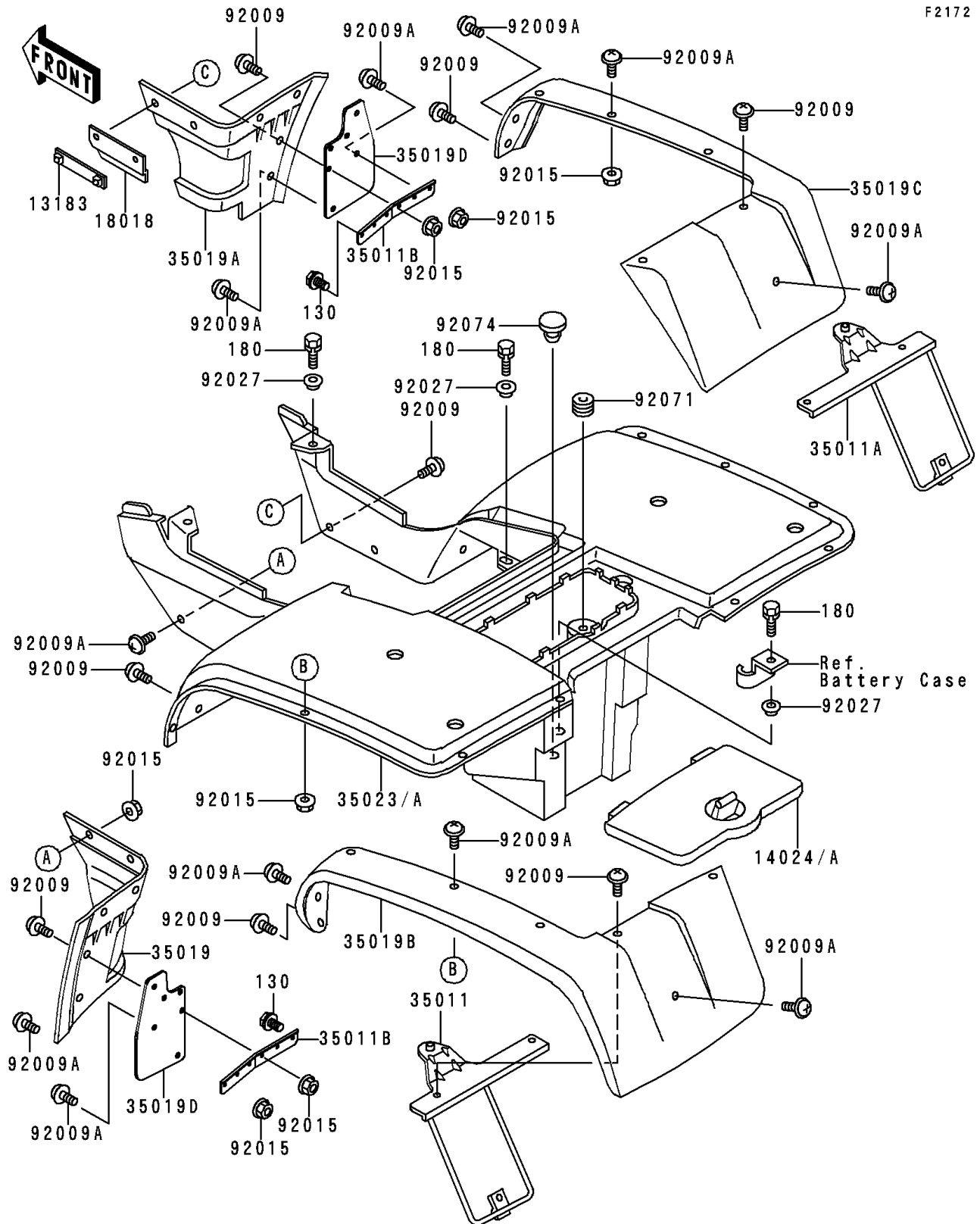

1992 Bayou 300 PARTS LIST

Rear Fender(s)

ITEM NAME	PART NUMBER	QUANTITY
BOLT-FLANGED,6X10,BLACK (Ref # 130)	130C0610	1
BOLT-UPSET-WS (Ref # 180)	180D0618	1
PLATE,HEAT GUARD (Ref # 13183)	13183-1035	1
COVER,REAR FENDER,BLACK (Ref # 14024)	14024-1095-6D	1
COVER,REAR FENDER,F.RED (Ref # 14024A)	14024-1095-6L	1
PLATE-HEAT GUARD (Ref # 18018)	18018-1071	1
STAY,REAR FLAP,LH (Ref # 35011)	35011-1418	1
STAY,REAR FLAP,RH (Ref # 35011A)	35011-1419	1
STAY,FLAP,OUTER (Ref # 35011B)	35011-1435	1
FLAP,FR,LH (Ref # 35019)	35019-1225	1
FLAP,FR,RH (Ref # 35019A)	35019-1226	1
FLAP,RR,LH (Ref # 35019B)	35019-1227	1
FLAP,RR,RH (Ref # 35019C)	35019-1228	1
FLAP,FR,OUTER (Ref # 35019D)	35019-1255	1
FENDER-REAR,BLACK (Ref # 35023)	35023-1139-6D	1
FENDER-REAR,F.RED (Ref # 35023A)	35023-1139-6L	1
SCREW,6X18,BLACK (Ref # 92009)	92009-1181	1
SCREW,6X14 (Ref # 92009A)	92009-1288	1
NUT,LOCK,FLANGED,6MM (Ref # 92015)	92015-1675	1
COLLAR,L=5.6 (Ref # 92027)	92027-1933	1
GROMMET (Ref # 92071)	92071-1131	1
PLUG,11X3.2 (Ref # 92074)	92074-038	1