

1995 Bayou 300 PARTS DIAGRAM

Front Suspension

F2152

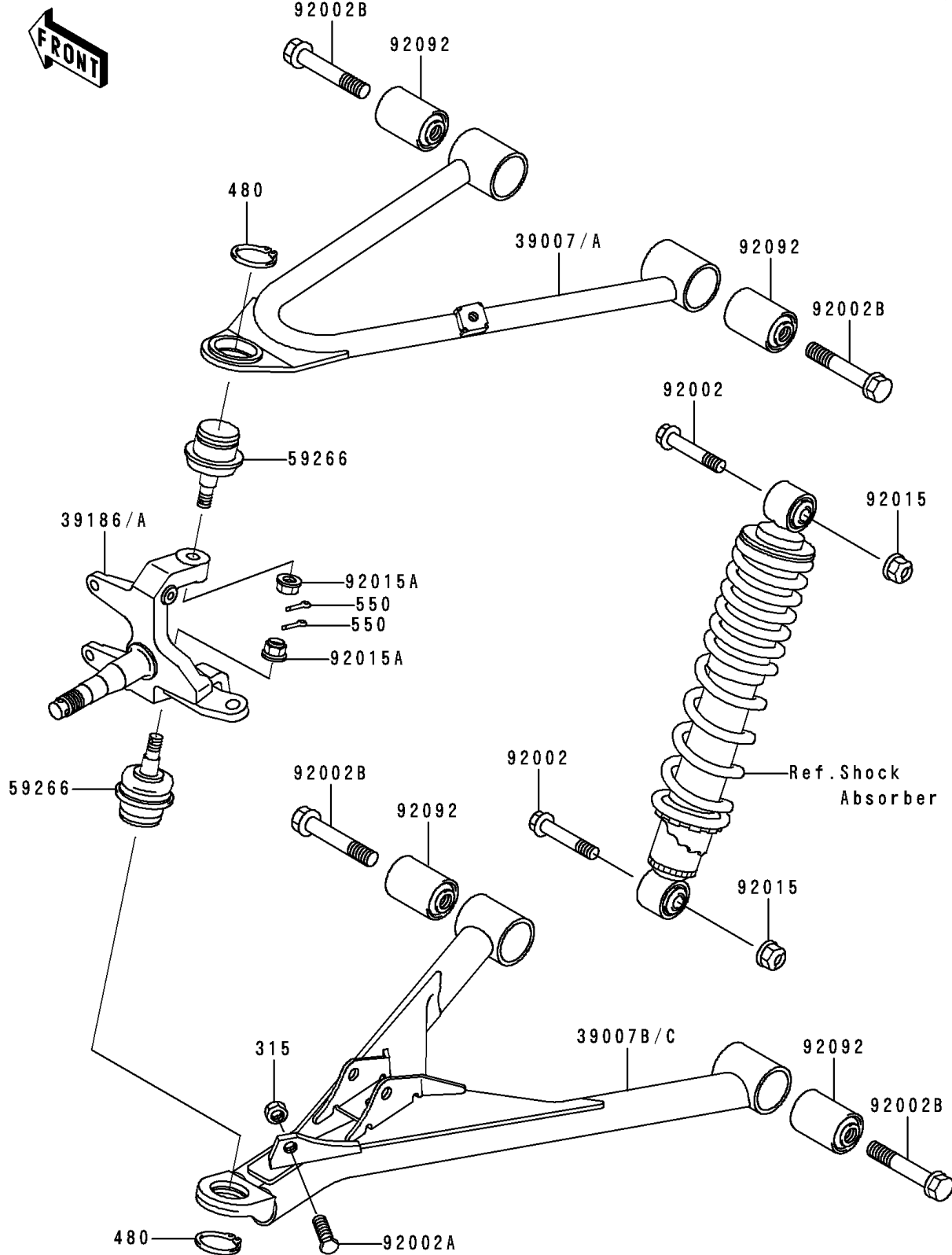

1995 Bayou 300 PARTS LIST

Front Suspension

ITEM NAME	PART NUMBER	QUANTITY
NUT-HEX-FINE (Ref # 315)	315J1000	2
CIRCLIP-TYPE-C,32MM (Ref # 480)	480J3200	4
PIN-COTTER,2.0X15 (Ref # 550)	550D2015	4
ARM-SUSP,FR,LH,UPP (Ref # 39007)	39007-1140	1
ARM-SUSP,FR,RH,UPP (Ref # 39007A)	39007-1141	1
ARM-SUSP,FR,LH,LWR (Ref # 39007B)	39007-1142	1
ARM-SUSP,FR,RH,LWR (Ref # 39007C)	39007-1143	1
KNUCKLE,LH (Ref # 39186)	39186-1083	1
KNUCKLE,RH (Ref # 39186A)	39186-1084	1
JOINT-BALL (Ref # 59266)	59266-1060	4
BOLT,FLANGED,10X53.5 (Ref # 92002)	92002-1529	4
BOLT,10X30 (Ref # 92002A)	92002-1559	2
BOLT,FLANGED,12X67 (Ref # 92002B)	92002-1861	8
NUT,LOCK,10MM (Ref # 92015)	92015-1597	4
NUT,LOCK,FLANGED,10MM (Ref # 92015A)	92015-1717	4
BUSHING-RUBBER (Ref # 92092)	92092-1065	8