

1995 Bayou 300 PARTS DIAGRAM

Front Bevel Gear

E3131

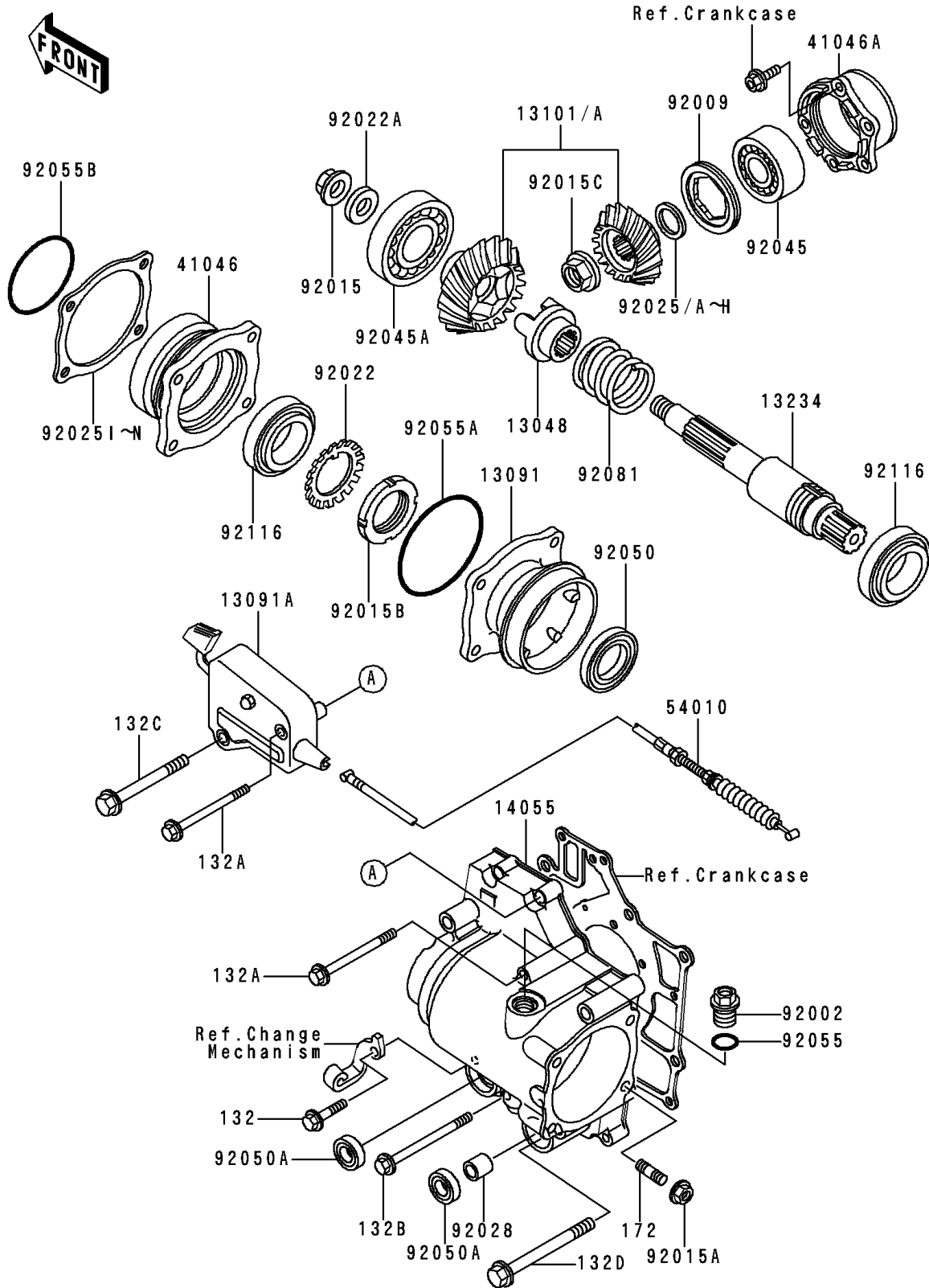

1995 Bayou 300 PARTS LIST

Front Bevel Gear

ITEM NAME	PART NUMBER	QUANTITY
CAM-DAMPER,FR (Ref # 13048)	13048-1059	1
HOLDER,GEAR CASE,FR (Ref # 13091)	13091-1377	1
HOLDER,DIFF LOCK (Ref # 13091A)	13091-1410	1
SHAFT-COMP,GEAR CASE,FR (Ref # 13234)	13234-1085	1
CASE-GEAR (Ref # 14055)	14055-1125	1
HOUSING-BEARING,GEAR CASE,FR (Ref # 41046)	41046-1066	1
HOUSING-BEARING,GEAR CASE,FR (Ref # 41046A)	41046-1098	1
CABLE (Ref # 54010)	54010-1069	1
BOLT,16X10 (Ref # 92002)	92002-1238	1
SCREW,55MM (Ref # 92009)	92009-1384	1
NUT,FLANGED,14MM (Ref # 92015)	92015-1341	1
NUT,8MM (Ref # 92015A)	92015-1402	1
NUT,RING 35MM (Ref # 92015B)	92015-1515	1
NUT (Ref # 92015C)	92015-1581	1
WASHER,LOCK (Ref # 92022)	92022-1687	1
WASHER,14.2X28X2.6 (Ref # 92022A)	92022-1688	1
SHIM,20.3X28X1.3 (Ref # 92025)	92025-1533	1
SHIM,20.3X28X0.7 (Ref # 92025A)	92025-1534	1
SHIM,20.3X28X0.8 (Ref # 92025B)	92025-1535	1
SHIM,20.3X28X0.9 (Ref # 92025C)	92025-1536	1
SHIM,20.3X28X1.0 (Ref # 92025D)	92025-1537	1
SHIM,20.3X28X1.2 (Ref # 92025E)	92025-1538	1
SHIM,20.3X28X0.15 (Ref # 92025F)	92025-1573	1
SHIM,20.3X28X0.20 (Ref # 92025G)	92025-1574	1
SHIM,20.3X28X1.1 (Ref # 92025H)	92025-1575	1
SHIM,T=0.10 (Ref # 92025I)	92025-1697	1
SHIM,T=0.15 (Ref # 92025J)	92025-1698	1
SHIM,T=0.50 (Ref # 92025K)	92025-1699	1
SHIM,T=0.80 (Ref # 92025L)	92025-1700	1

1995 Bayou 300 PARTS LIST

Front Bevel Gear

ITEM NAME	PART NUMBER	QUANTITY
SHIM,T=1.00 (Ref # 92025M)	92025-1701	1
SHIM,T=1.20 (Ref # 92025N)	92025-1702	1
BUSHING (Ref # 92028)	92028-1347	1
BEARING-BALL,5304 (Ref # 92045)	92045-1144	1
BEARING-BALL,6206CM (Ref # 92045A)	92045-1155	1
SEAL-OIL (Ref # 92050)	92050-057	1
SEAL-OIL (Ref # 92050A)	92050-082	1
BOLT-FLANGED-SMALL (Ref # 132)	132J0630	1
BOLT-FLANGED-SMALL (Ref # 132A)	132J0675	1
BOLT-FLANGED-SMALL (Ref # 132B)	132J0685	1
BOLT-FLANGED-SMALL (Ref # 132C)	132J0875	1
BOLT-FLANGED-SMALL (Ref # 132D)	132J0890	1
BOLT-STUD,8X25 (Ref # 172)	172G0825	1
RING-O,ID=13.8 (Ref # 92055)	92055-1141	1
RING-O,76MM (Ref # 92055A)	92055-1213	1
RING-O (Ref # 92055B)	92055-1316	1
SPRING,DAMPER (Ref # 92081)	92081-1854	1
BEARING-ROLLER (Ref # 92116)	92116-1055	1
GEAR-ASSY,FRONT BEVEL (Ref # 13101)	13101-5079	1
GEAR-ASSY,FRONT BEVEL (Ref # 13101A)	13101-5080	1