

1995 Bayou 300 PARTS DIAGRAM

Gear Change Mechanism

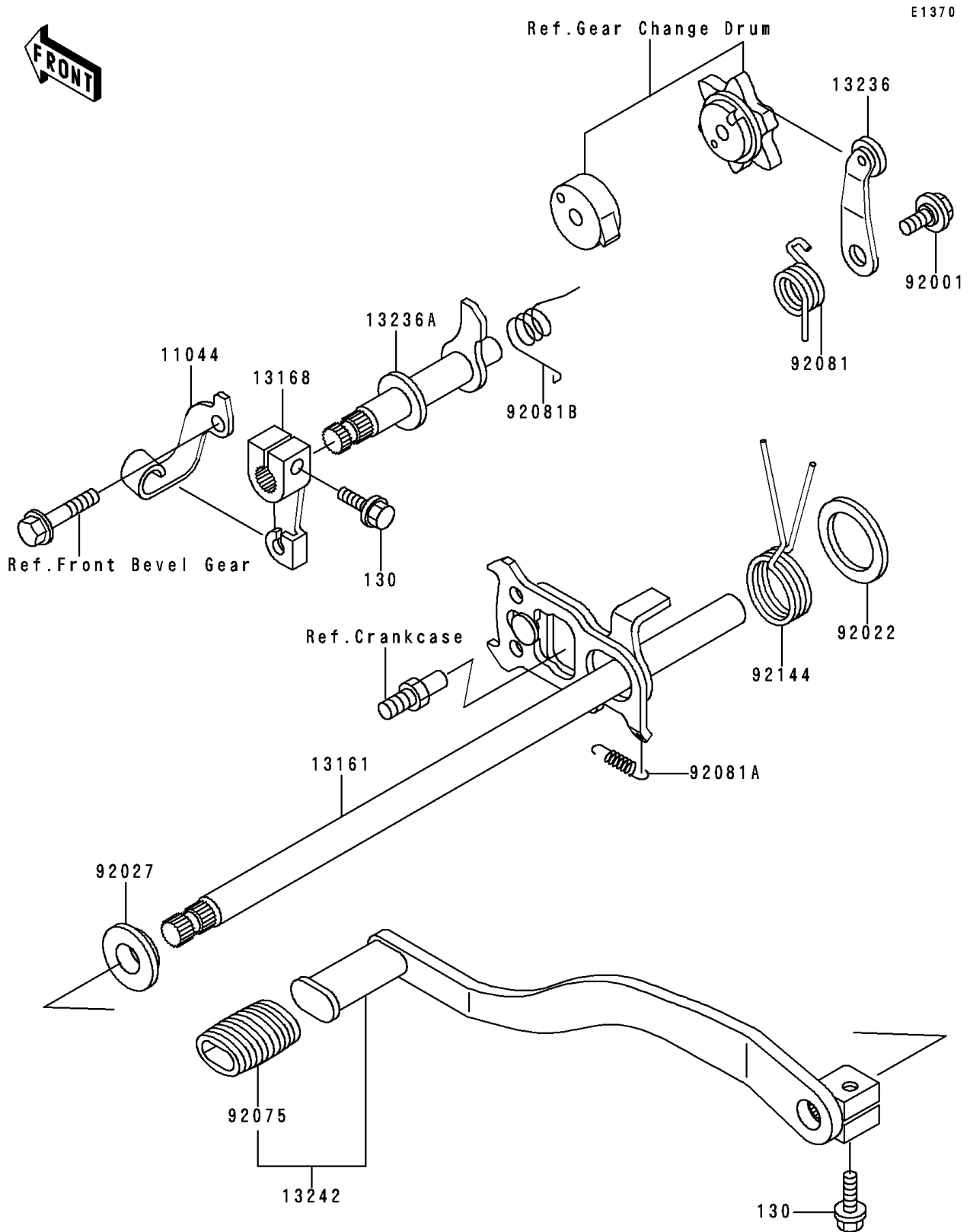

1995 Bayou 300 PARTS LIST

Gear Change Mechanism

ITEM NAME	PART NUMBER	QUANTITY
BOLT-FLANGED,6X20,BLACK (Ref # 130)	130S0620	1
BRACKET,REVERSE CABLE (Ref # 11044)	11044-1303	1
LEVER-COMP-CHANGE SHAFT (Ref # 13161)	13161-1196	1
LEVER,REVERSE (Ref # 13168)	13168-1267	1
LEVER-COMP,CHANGE DRUM (Ref # 13236)	13236-1178	1
LEVER-COMP,REVERSE (Ref # 13236A)	13236-1239	1
LEVER-ASSY-CHANGE,PEDAL (Ref # 13242)	13242-1236	1
BOLT,GEAR CHANGE LEVER (Ref # 92001)	92001-1715	1
WASHER,25.5X36X1 (Ref # 92022)	92022-057	1
COLLAR,L=5.2 (Ref # 92027)	92027-1891	1
DAMPER,CHANGE PEDAL (Ref # 92075)	92075-1585	1
SPRING (Ref # 92081)	92081-1496	1
SPRING,CHANGE LEVER (Ref # 92081A)	92081-1753	1
SPRING,REVERSE LEVER (Ref # 92081B)	92081-1850	1
SPRING (Ref # 92144)	92144-1798	1