

2007 Ninja® 500R PARTS DIAGRAM

Chassis Electrical Equipment

F2760

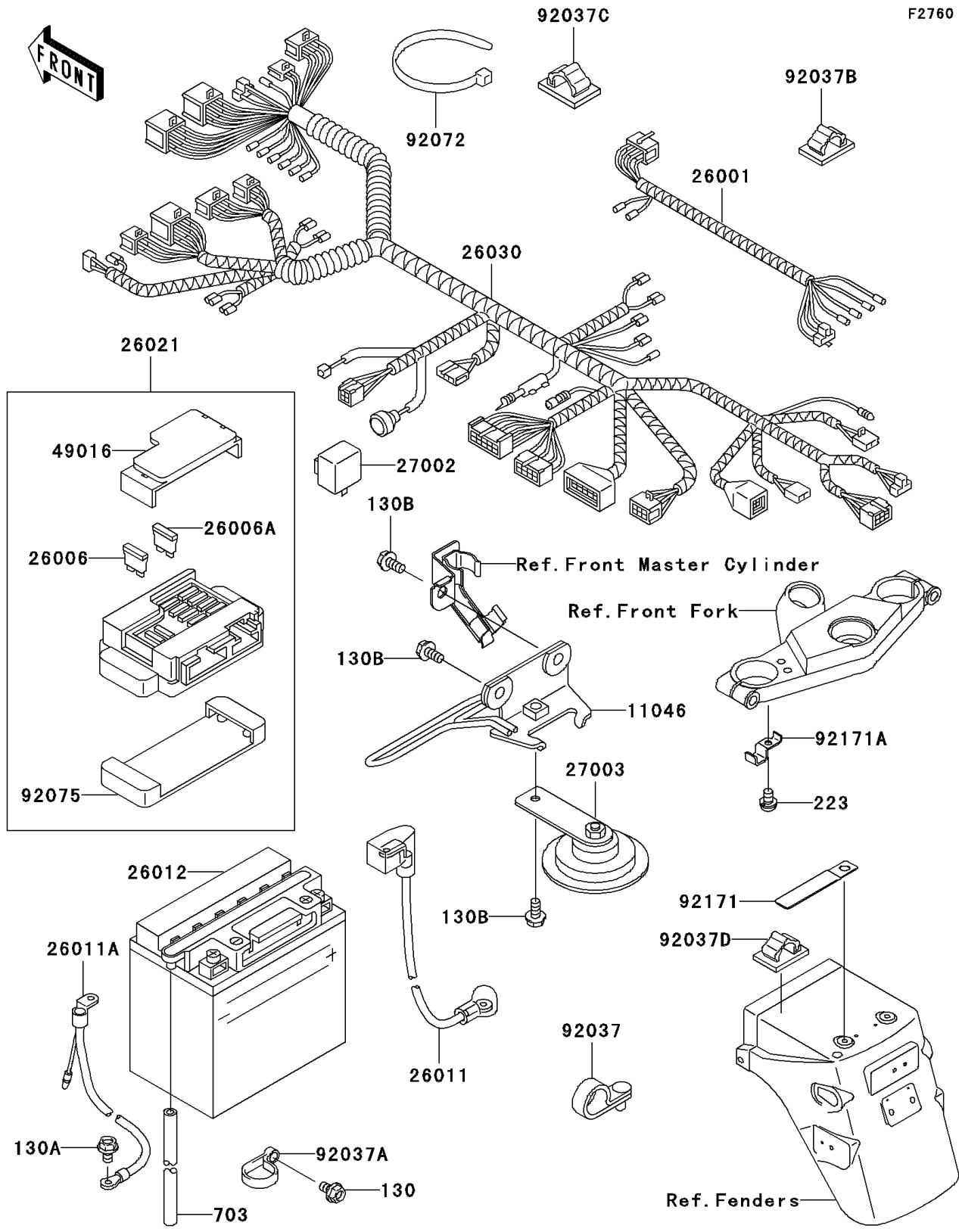

2007 Ninja® 500R PARTS LIST

Chassis Electrical Equipment

ITEM NAME	PART NUMBER	QUANTITY
BOLT-FLANGED,6X10 (Ref # 130)	130AA0610	1
BOLT-FLANGED,6X10 (Ref # 130A)	130BA0610	1
BOLT-FLANGED,6X12 (Ref # 130B)	130BB0612	3
SCREW-PAN-WS-CROS,6X10 (Ref # 223)	223AB0610	1
TUBE-RUBBER,8X12X530 (Ref # 703)	703A08530	1
BRACKET,HORN&CABLE (Ref # 11046)	11046-1233	1
HARNESS,FRONT SIGNAL LAMP (Ref # 26001)	26001-1859	1
FUSE,30A-G (Ref # 26006)	26006-1067	1
FUSE,10A-R (Ref # 26006A)	26006-1068	8
WIRE-LEAD,BATTERY(+) (Ref # 26011)	26011-1388	1
WIRE-LEAD,BATTERY(-) (Ref # 26011A)	26011-1389	1
BATTERY,FB14L-A2,12V 14AH (Ref # 26012)	26012-1349	1
JUNCTION BOX (Ref # 26021)	26021-1089	1
HARNESS,MAIN (Ref # 26030)	26030-1733	1
RELAY-ASSY,TURN SIGNAL (Ref # 27002)	27002-1101	1
HORN (Ref # 27003)	27003-1288	1
COVER-SEAL,FUSE (Ref # 49016)	49016-1177	1
CLAMP,SPEED,L=58 (Ref # 92037)	92037-1163	1
CLAMP,HOSE (Ref # 92037A)	92037-1727	1
CLAMP,HARNESS (Ref # 92037B)	92037-1793	2
CLAMP,TUBE (Ref # 92037C)	92037-1794	1
CLAMP,HARNESS (Ref # 92037D)	92037-1816	1
BAND,L=202 (Ref # 92072)	92072-1195	9
DAMPER,JUNCTION BOX (Ref # 92075)	92075-1688	1
CLAMP (Ref # 92171)	92171-0652	1
CLAMP,HARNESS (Ref # 92171A)	92171-1199	1