

1989 Bayou 300 PARTS DIAGRAM

Front Fender

F2171

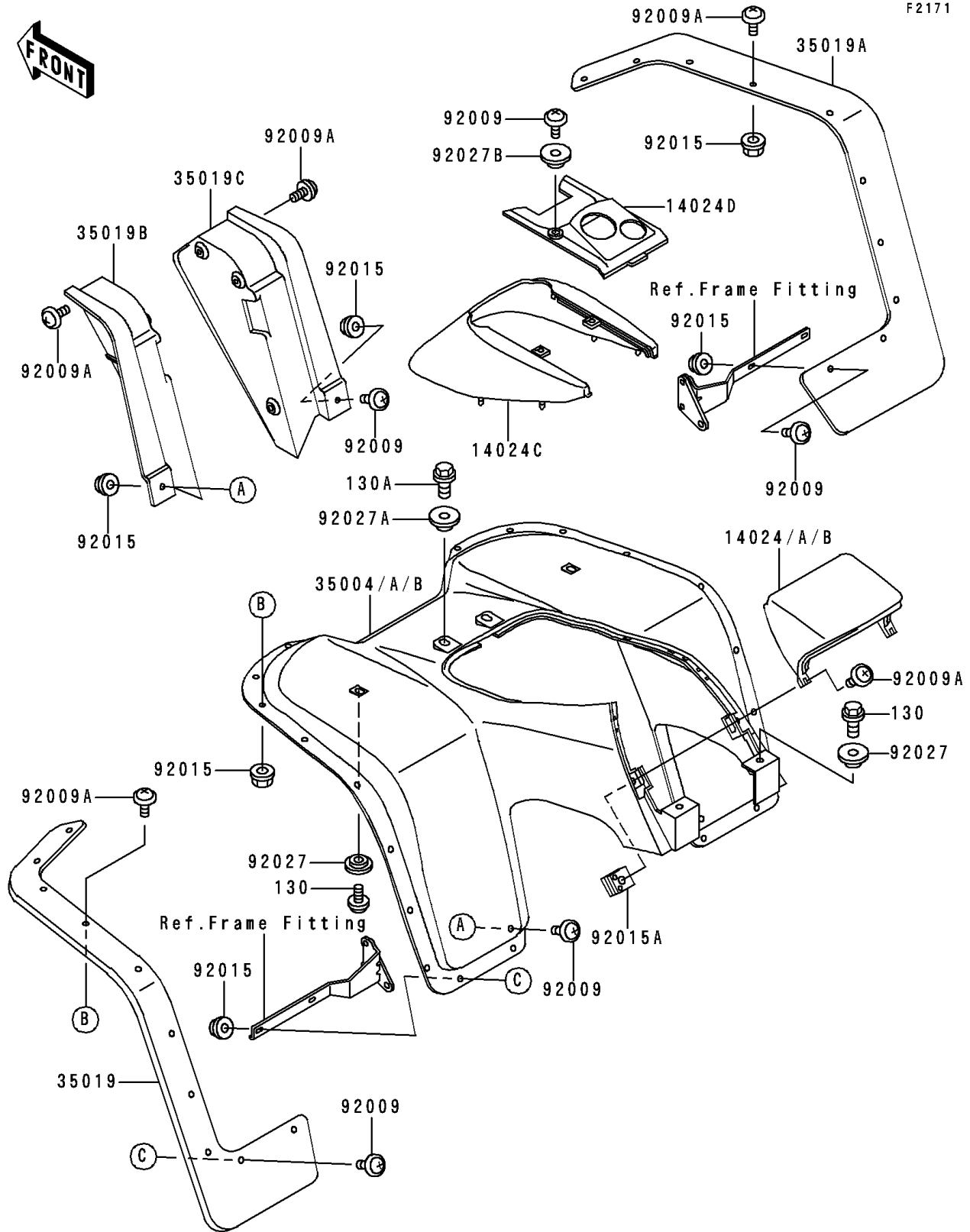

1989 Bayou 300 PARTS LIST

Front Fender

ITEM NAME	PART NUMBER	QUANTITY
BOLT-FLANGED,6X14 (Ref # 130)	130C0614	4
BOLT-FLANGED,8X20 (Ref # 130A)	130C0820	2
COVER,FRONT FENDER,RR,BLACK (Ref # 14024)	14024-1093-6D	1
COVER,FRONT FENDER,RR,F.RED (Ref # 14024B)	14024-1093-6L	1
COVER,FRONT FENDER,FR,BLACK (Ref # 14024C)	14024-1544-6D	1
COVER,FUEL TANK,BLACK (Ref # 14024D)	14024-1545-6D	1
FENDER-FRONT,BLACK (Ref # 35004)	35004-1172-6D	1
FENDER-FRONT,F.RED (Ref # 35004B)	35004-1172-6L	1
FLAP,FR,LH (Ref # 35019)	35019-1146	1
FLAP,FR,RH (Ref # 35019A)	35019-1147	1
FLAP,FR,INSIDE,LH (Ref # 35019B)	35019-1208	1
FLAP,FR,INSIDE,RH (Ref # 35019C)	35019-1209	1
SCREW,6X18,BLACK (Ref # 92009)	92009-1181	8
SCREW,6X14 (Ref # 92009A)	92009-1288	24
NUT,LOCK,FLANGED,6MM (Ref # 92015)	92015-1675	22
NUT,CLAMP,6MM (Ref # 92015A)	92015-1678	4
COLLAR,L=4.7 (Ref # 92027)	92027-122	4
COLLAR,L=5.6 (Ref # 92027A)	92027-1909	2
COLLAR,L=4.7 (Ref # 92027B)	92027-1964	2