

1987 Bayou 185 PARTS DIAGRAM

Carrier(s)

F2520-0004

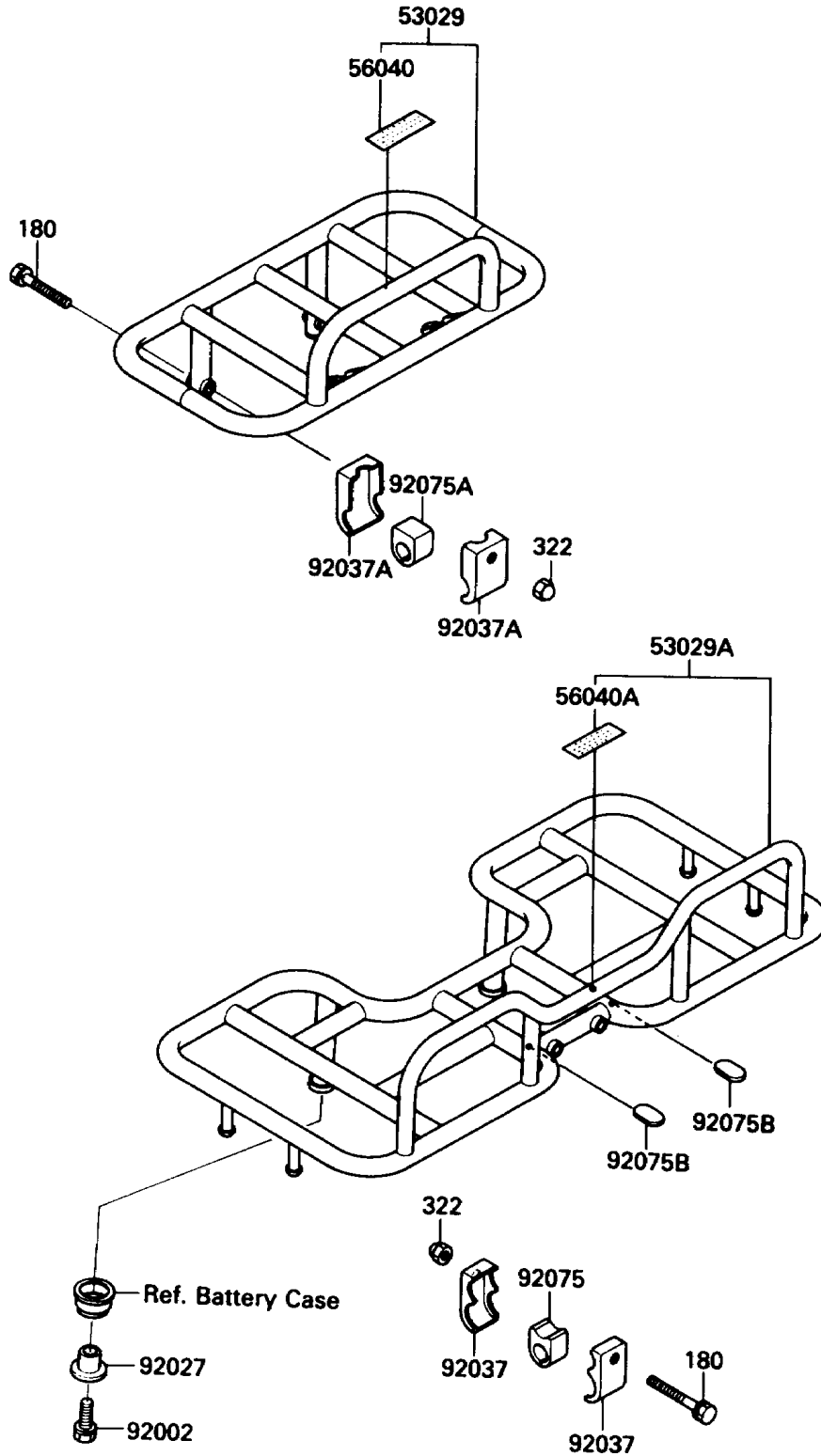

1987 Bayou 185 PARTS LIST

Carrier(s)

ITEM NAME	PART NUMBER	QUANTITY
CARRIER,FR (Ref # 53029)	53029-1070	1
CARRIER,RR (Ref # 53029A)	53029-1072	1
LABEL-WARNING,MAXIMUM LOAD (Ref # 56040)	56040-1142	1
LABEL-WARNING,MAXIMUM LOAD (Ref # 56040A)	56040-1143	1
BOLT,10X32 (Ref # 92002)	92002-1244	2
COLLAR (Ref # 92027)	92027-1895	2
CLAMP,RR CARRIER (Ref # 92037)	92037-1660	4
CLAMP,FR CARRIER (Ref # 92037A)	92037-1661	4
DAMPER,CARRIER (Ref # 92075)	92075-1728	2
DAMPER,CARRIER (Ref # 92075A)	92075-1729	2
DAMPER (Ref # 92075B)	92075-1841	2
BOLT-UPSET-WS (Ref # 180)	180J0640	4
NUT-CAP,6MM,BLACK (Ref # 322)	322C0600	4