

1987 Bayou 185 PARTS DIAGRAM

Brake Pedal

F2260-0150

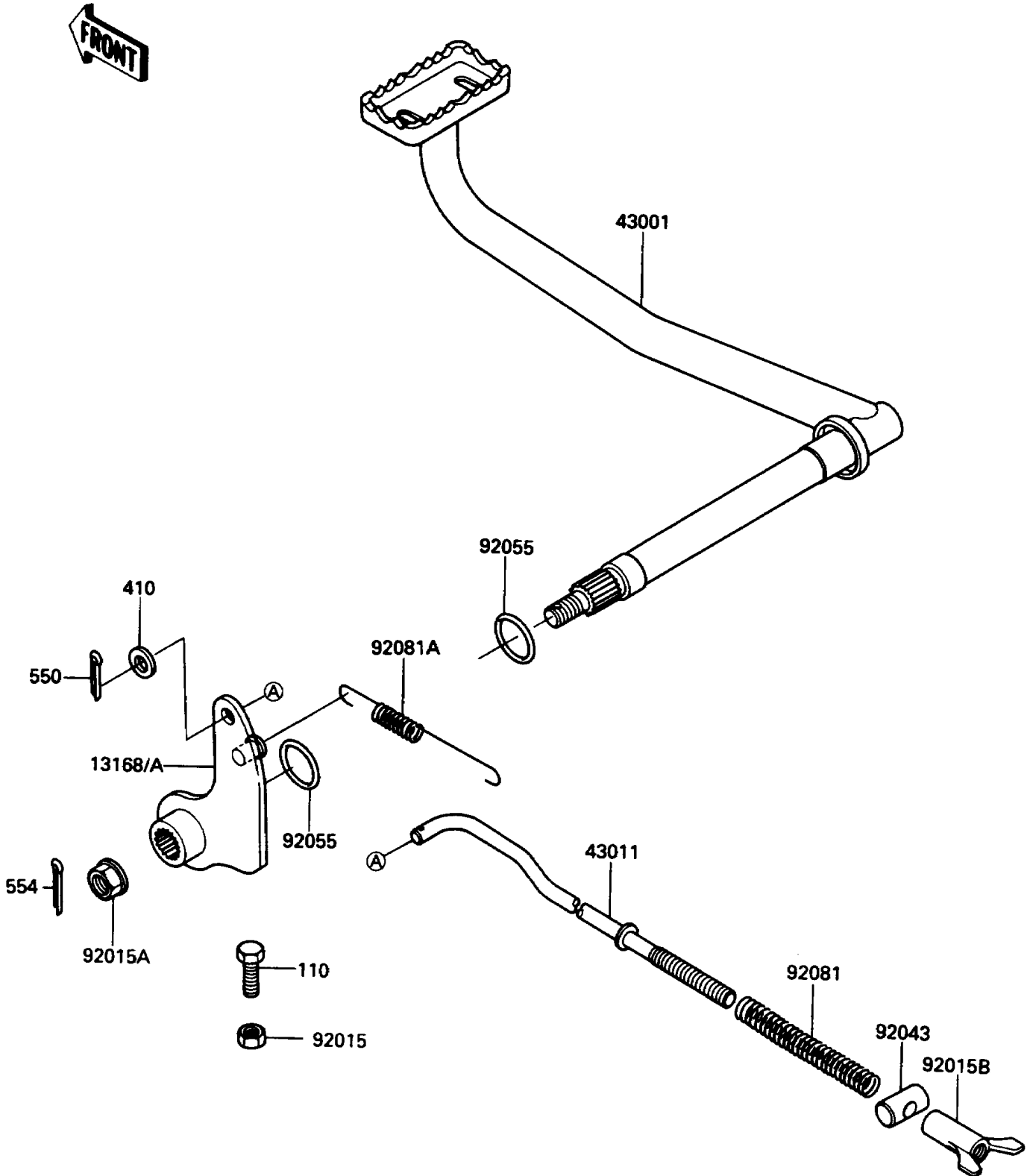

1987 Bayou 185 PARTS LIST

Brake Pedal

ITEM NAME	PART NUMBER	QUANTITY
LEVER,BRAKE (Ref # 13168)	13168-1246	1
LEVER-BRAKE,PEDAL (Ref # 43001)	43001-1171	1
ROD-BRAKE (Ref # 43011)	43011-1038	1
NUT,6MM (Ref # 92015)	92015-1410	1
NUT,FLANGED,10MM (Ref # 92015A)	92015-1415	1
NUT,WING,6MM (Ref # 92015B)	92015-1497	1
PIN,12X20 (Ref # 92043)	92043-1280	1
RING-O,23.8MM (Ref # 92055)	92055-1257	1
SPRING,BRAKE ROD (Ref # 92081)	43012-001	1
SPRING,SIDE STAND,L=177,BLACK (Ref # 92081A)	92081-1480	1
BOLT (Ref # 110)	110D0622	1
WASHER-PLAIN-SMALL,6MM (Ref # 410)	410B0600	1
PIN-COTTER,2.0X15 (Ref # 550)	550D2015	1
PIN-SNAP,10MM (Ref # 554)	554A1000	1