

1986 Bayou 185 PARTS DIAGRAM

Front Bevel Gear

E3131-0008

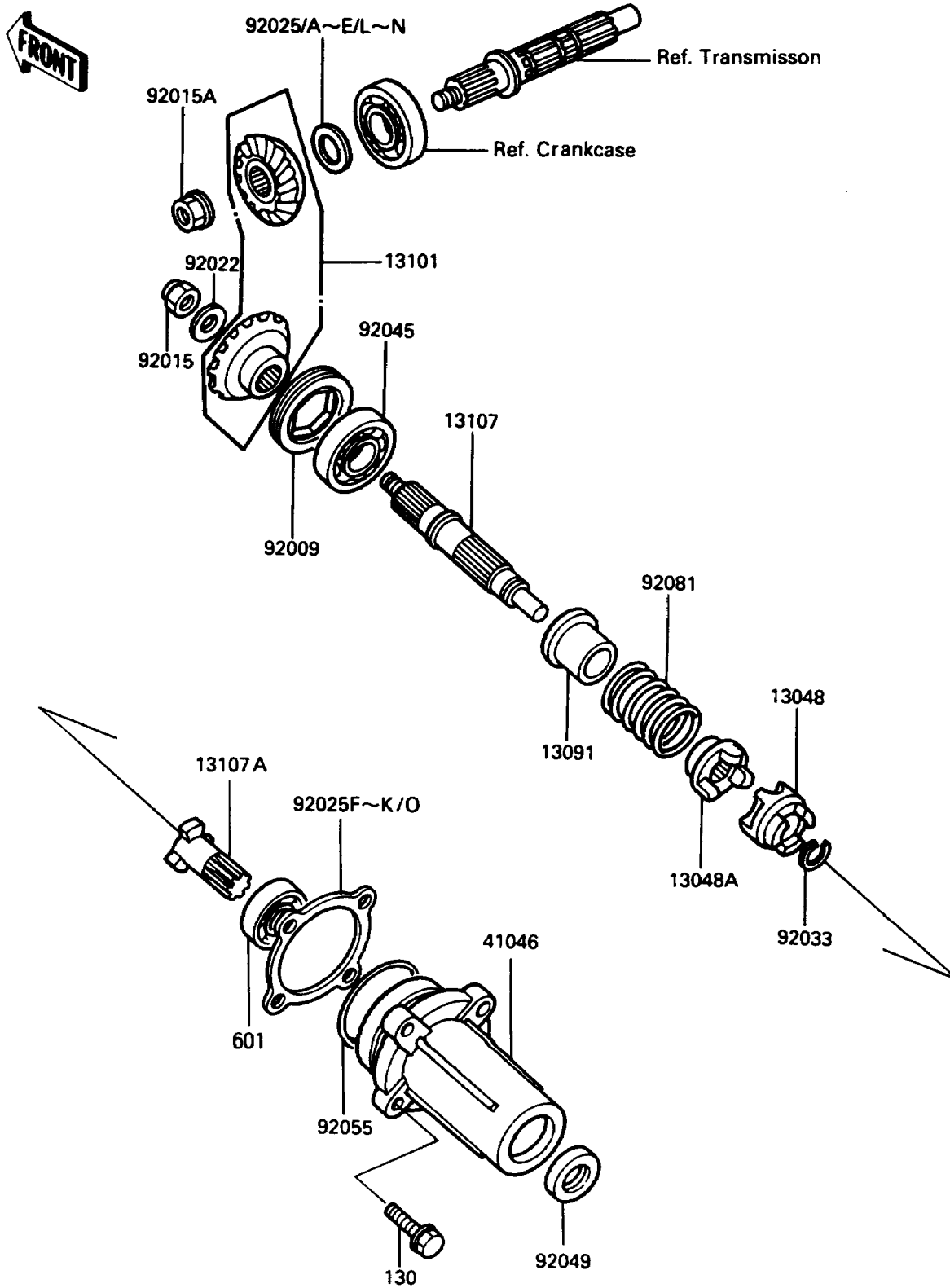

1986 Bayou 185 PARTS LIST

Front Bevel Gear

ITEM NAME	PART NUMBER	QUANTITY
CAM-DAMPER (Ref # 13048)	13048-1053	1
CAM-DAMPER (Ref # 13048A)	13048-1054	1
HOLDER (Ref # 13091)	13091-1278	1
GEAR-ASSY,FRONT BEVEL (Ref # 13101)	13101-5047	1
SHAFT,BEVEL GEAR,FR (Ref # 13107)	13107-1109	1
SHAFT (Ref # 13107A)	13107-1110	1
HOUSING-BEARING,GEAR (Ref # 41046)	41046-1051	1
SCREW (Ref # 92009)	92009-1290	1
NUT,12MM (Ref # 92015)	92015-1182	1
NUT,FLANGED,14MM (Ref # 92015A)	92015-1341	1
WASHER (Ref # 92022)	92022-1611	1
SHIM,20.3X28X1.3 (Ref # 92025)	92025-1533	AR
SHIM,20.3X28X0.7 (Ref # 92025A)	92025-1534	AR
SHIM,20.3X28X0.8 (Ref # 92025B)	92025-1535	AR
SHIM,20.3X28X0.9 (Ref # 92025C)	92025-1536	AR
SHIM,20.3X28X1.0 (Ref # 92025D)	92025-1537	AR
SHIM,20.3X28X1.2 (Ref # 92025E)	92025-1538	AR
SHIM,T=0.1 (Ref # 92025F)	92025-1539	AR
SHIM,T=0.7 (Ref # 92025G)	92025-1540	AR
SHIM,T=0.8 (Ref # 92025H)	92025-1541	AR
SHIM,T=0.9 (Ref # 92025I)	92025-1542	AR
SHIM,T=1.0 (Ref # 92025J)	92025-1543	AR
SHIM,T=1.2 (Ref # 92025K)	92025-1544	AR
SHIM,20.3X28X0.15 (Ref # 92025L)	92025-1573	AR
SHIM,20.3X28X0.20 (Ref # 92025M)	92025-1574	AR
SHIM,20.3X28X1.1 (Ref # 92025N)	92025-1575	AR
SHIM,T=0.15 (Ref # 92025O)	92025-1576	AR
RING-SNAP,17MM (Ref # 92033)	92033-1060	1
BEARING-BALL,6304CM (Ref # 92045)	92045-1108	1

1986 Bayou 185 PARTS LIST

Front Bevel Gear

ITEM NAME	PART NUMBER	QUANTITY
SEAL-OIL (Ref # 92049)	92049-1169	1
RING-O,ID=57.6 (Ref # 92055)	92055-1038	1
SPRING (Ref # 92081)	92081-1647	1
BOLT-FLANGED,8X30 (Ref # 130)	130P0830	4
BEARING-BALL,#6004C3 (Ref # 601)	601B6004	1