

# 2004 KLR650 PARTS DIAGRAM

Rear Suspension

F2150

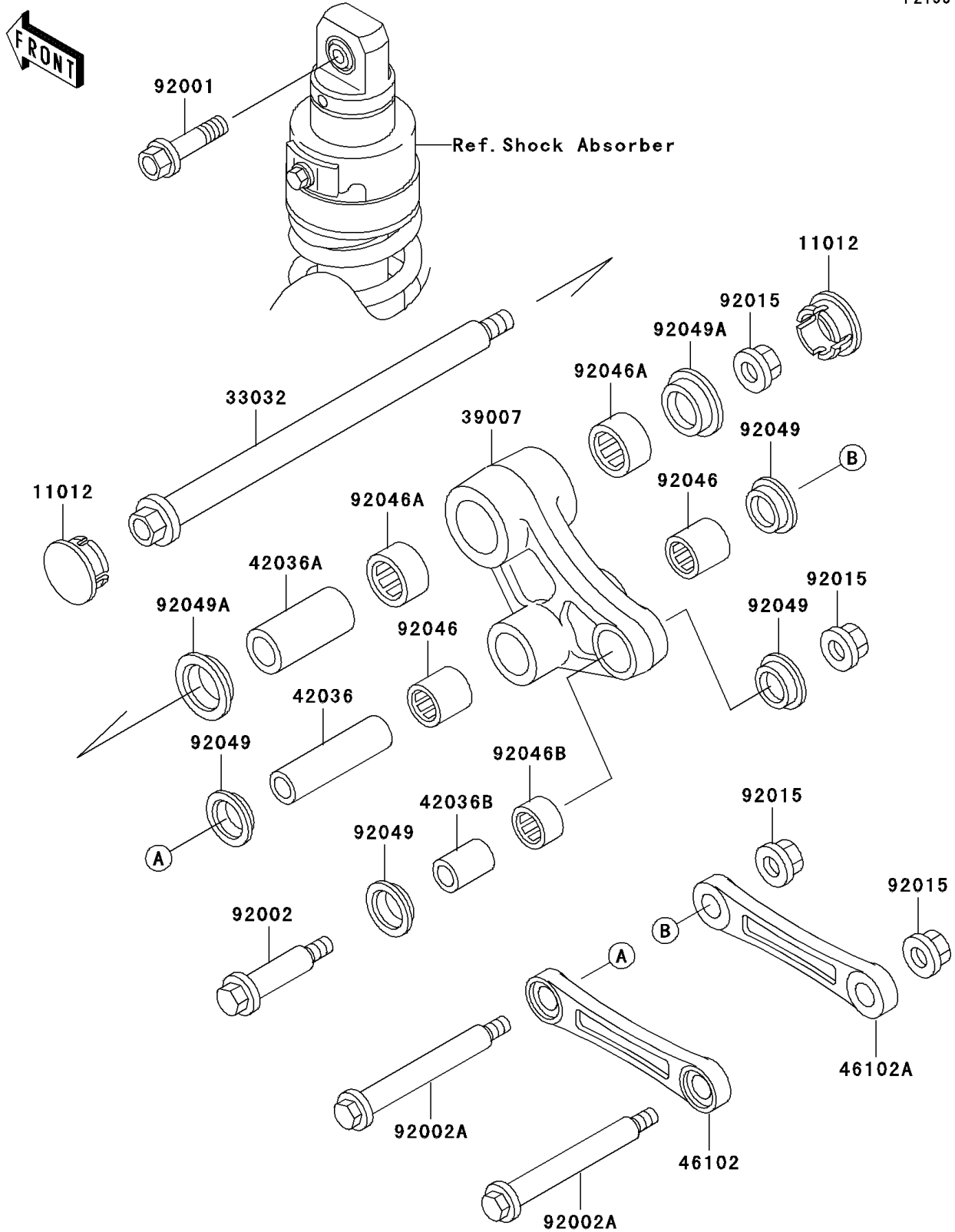

## 2004 KLR650 PARTS LIST

### Rear Suspension

ITEM NAME	PART NUMBER	QUANTITY
CAP,32X14 (Ref # 11012)	11012-1559	2
SHAFT-SWING ARM (Ref # 33032)	33032-1129	1
ARM-SUSP,UNI TRAK (Ref # 39007)	39007-1119	1
SLEEVE,15X20X82 (Ref # 42036)	42036-1205	1
SLEEVE,20X28X60 (Ref # 42036A)	42036-1207	1
SLEEVE,15X20X30 (Ref # 42036B)	42036-1208	1
ROD,SUSPENSION,LH (Ref # 46102)	46102-1227	1
ROD,SUSPENSION,RH (Ref # 46102A)	46102-1228	1
BOLT,12X45 (Ref # 92001)	92001-1939	1
BOLT,FLANGED,14X64 (Ref # 92002)	92002-1869	1
BOLT,FLANGED,14X120 (Ref # 92002A)	92002-1870	2
NUT,14MM (Ref # 92015)	92015-1459	4
BEARING-NEEDLE,BM202726 (Ref # 92046)	92046-1110	2
BEARING-NEEDLE,BM2817 (Ref # 92046A)	92046-1111	2
BEARING-NEEDLE,BM202715 (Ref # 92046B)	92046-1112	1
SEAL-OIL,ARM (Ref # 92049)	92049-1109	4
SEAL-OIL (Ref # 92049A)	92049-1181	2