

2000 Super Sherpa PARTS DIAGRAM

Camshaft(s)/Tensioner

E1230

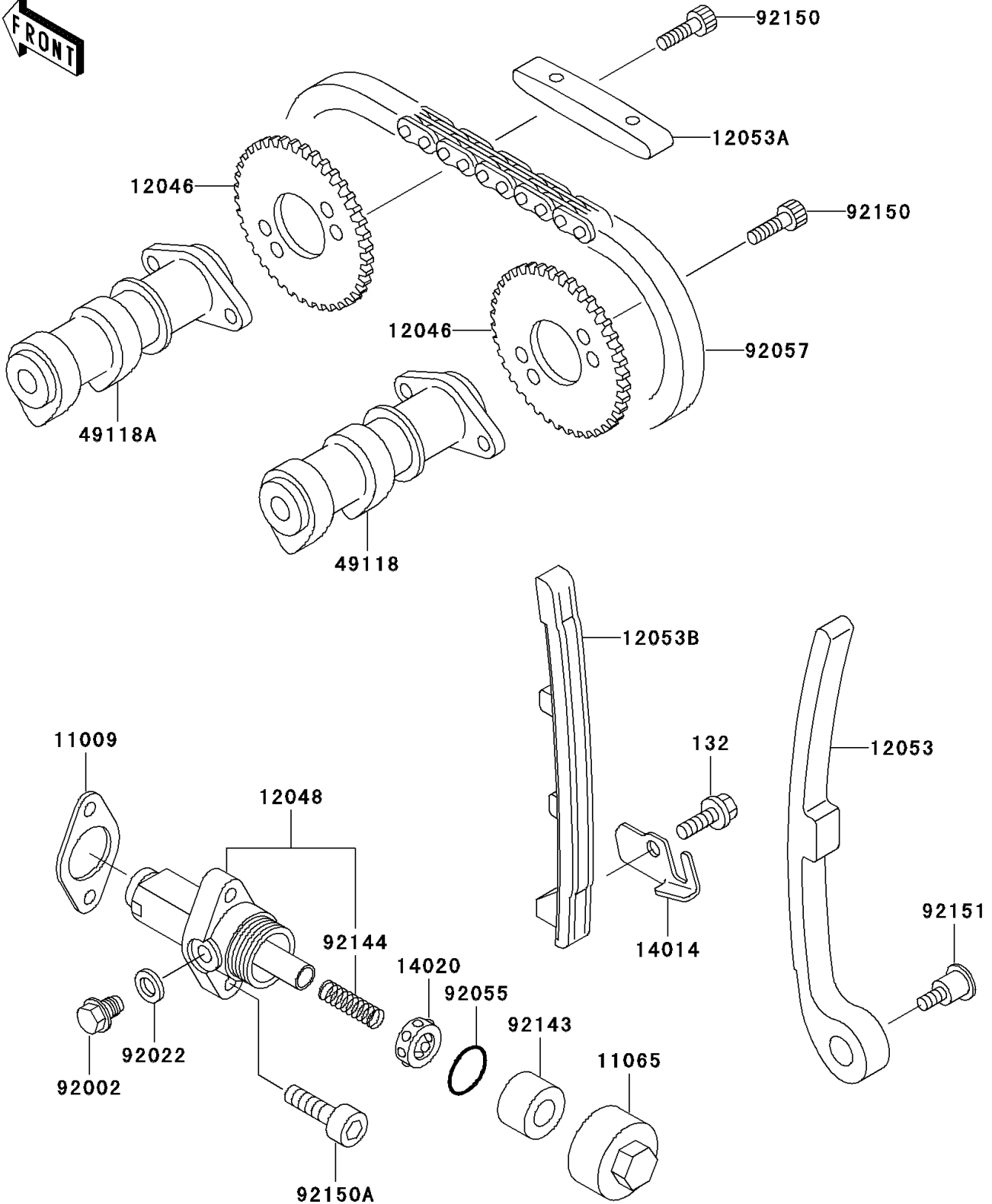

2000 Super Sherpa PARTS LIST

Camshaft(s)/Tensioner

ITEM NAME	PART NUMBER	QUANTITY
BOLT-FLANGED-SMALL (Ref # 132)	132J0612	1
GASKET,TENSIONER (Ref # 11009)	11009-1858	1
CAP (Ref # 11065)	11065-1128	1
SPROCKET (Ref # 12046)	12046-1186	2
TENSIONER-ASSY (Ref # 12048)	12048-1156	1
GUIDE-CHAIN,RR (Ref # 12053)	12053-1386	1
GUIDE-CHAIN,UPP (Ref # 12053A)	12053-1390	1
GUIDE-CHAIN,FR (Ref # 12053B)	12053-1401	1
PLATE-POSITION (Ref # 14014)	14014-1139	1
RETAINER,TENSIONER (Ref # 14020)	14020-1054	1
CAMSHAFT-COMP,INTAKE (Ref # 49118)	49118-1162	1
CAMSHAFT-COMP,EXHAUST (Ref # 49118A)	49118-1163	1
BOLT,6MM (Ref # 92002)	92002-1356	1
WASHER,6.2X11X1 (Ref # 92022)	92022-304	1
RING-O,TENSIONER (Ref # 92055)	92055-1555	1
CHAIN,CAM,92RH2010 (Ref # 92057)	92057-1440	1
COLLAR,TENSIONER (Ref # 92143)	92143-1836	1
SPRING,TENSIONER (Ref # 92144)	92144-1921	1
BOLT,SOCKET,6X10 (Ref # 92150)	92150-1650	4
BOLT,SOCKET,6X20 (Ref # 92150A)	92150-1795	2
BOLT,L=30 (Ref # 92151)	92151-1154	1