

1987 KLR250 PARTS DIAGRAM

Ignition Switch

F2770-0276

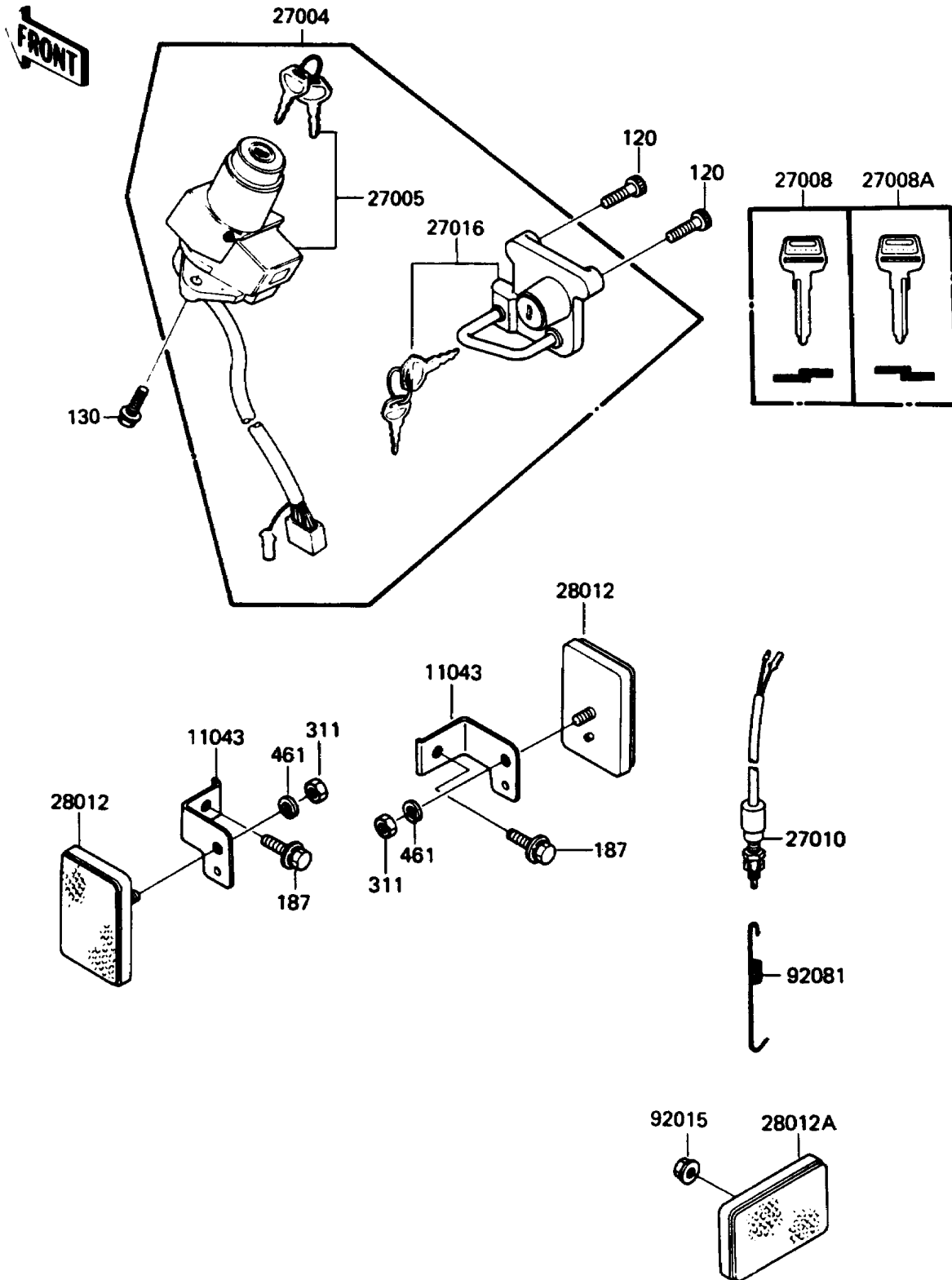

1987 KLR250 PARTS LIST

Ignition Switch

ITEM NAME	PART NUMBER	QUANTITY
BRACKET,REFLECTOR,FR (Ref # 11043)	11043-1362	2
SWITCH-ASSY (Ref # 27004)	27004-5218	1
SWITCH-ASSY-IGNITION (Ref # 27005)	27005-1103	1
KEY-LOCK,BLANK,#A (Ref # 27008)	27008-1034	1
KEY-LOCK,BLANK,#B (Ref # 27008A)	27008-1035	1
SWITCH,REAR BRAKE (Ref # 27010)	27010-1019	1
LOCK-ASSY,HELMET (Ref # 27016)	27016-5075	1
REFLECTOR-REFLEX (Ref # 28012)	28012-1003	2
REFLECTOR-REFLEX,RR (Ref # 28012A)	28012-1054	3
NUT,FLANGED,5MM (Ref # 92015)	92015-1259	3
SPRING,BRAKE LAMP SWITCH (Ref # 92081)	92081-1704	1
BOLT-SOCKET (Ref # 120)	120S0612	2
BOLT-FLANGED,6X14 (Ref # 130)	130D0614	2
BOLT-UPSET-WSP (Ref # 187)	187C0614	2
NUT-HEX (Ref # 311)	311B0500	2
WASHER-SPRING,5MM (Ref # 461)	461F0500	2