

1989 KLR250 PARTS DIAGRAM

Camshaft(s)/Tensioner

E1230-0050

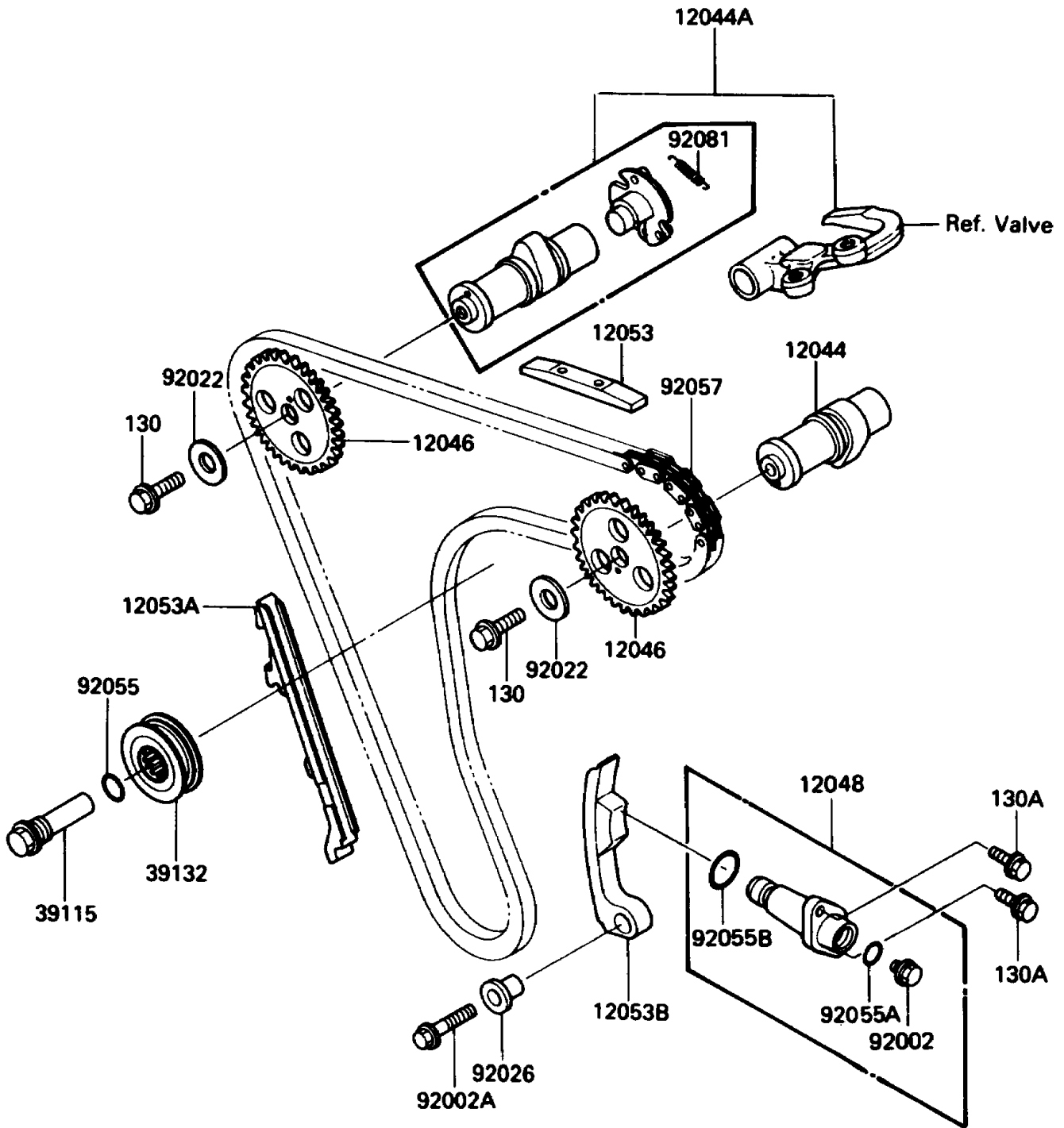

1989 KLR250 PARTS LIST

Camshaft(s)/Tensioner

ITEM NAME	PART NUMBER	QUANTITY
CAMSHAFT-VALVE,INTAKE (Ref # 12044)	12044-1119	1
CAMSHAFT-VALVE,EXHAUST (Ref # 12044A)	12044-5006	1
SPROCKET,42T (Ref # 12046)	12046-1063	2
TENSIONER-ASSY,CAM CHAIN (Ref # 12048)	12048-1066	1
GUIDE-CHAIN,UPP (Ref # 12053)	12053-1107	1
GUIDE-CHAIN,FR (Ref # 12053A)	12053-1125	1
GUIDE-CHAIN,RR (Ref # 12053B)	12053-1126	1
SHAFT-IDLER (Ref # 39115)	39115-1051	1
SPROCKET-ASSY-IDLER (Ref # 39132)	39132-1052	1
BOLT,TENSIONER (Ref # 92002)	92002-1302	1
BOLT (Ref # 92002A)	92002-1478	1
WASHER,10X22X3 (Ref # 92022)	92022-1365	2
SPACER,L=28.3 (Ref # 92026)	92026-1231	1
RING-O,ID=13.8 (Ref # 92055)	92055-1141	1
RING-O,TENSIONER BOLT (Ref # 92055A)	92055-1248	1
RING-O,TENSIONER (Ref # 92055B)	92055-1249	1
CHAIN,CAM,79RH2010-158L (Ref # 92057)	92057-1170	1
SPRING,DECOMPRESSOR (Ref # 92081)	92081-1626	1
BOLT-FLANGED,10X25 (Ref # 130)	130G1025	2
BOLT-FLANGED,6X25 (Ref # 130A)	130J0625	2