

2004 KLR250 PARTS DIAGRAM

Front Brake(D21/D22)

F2292A

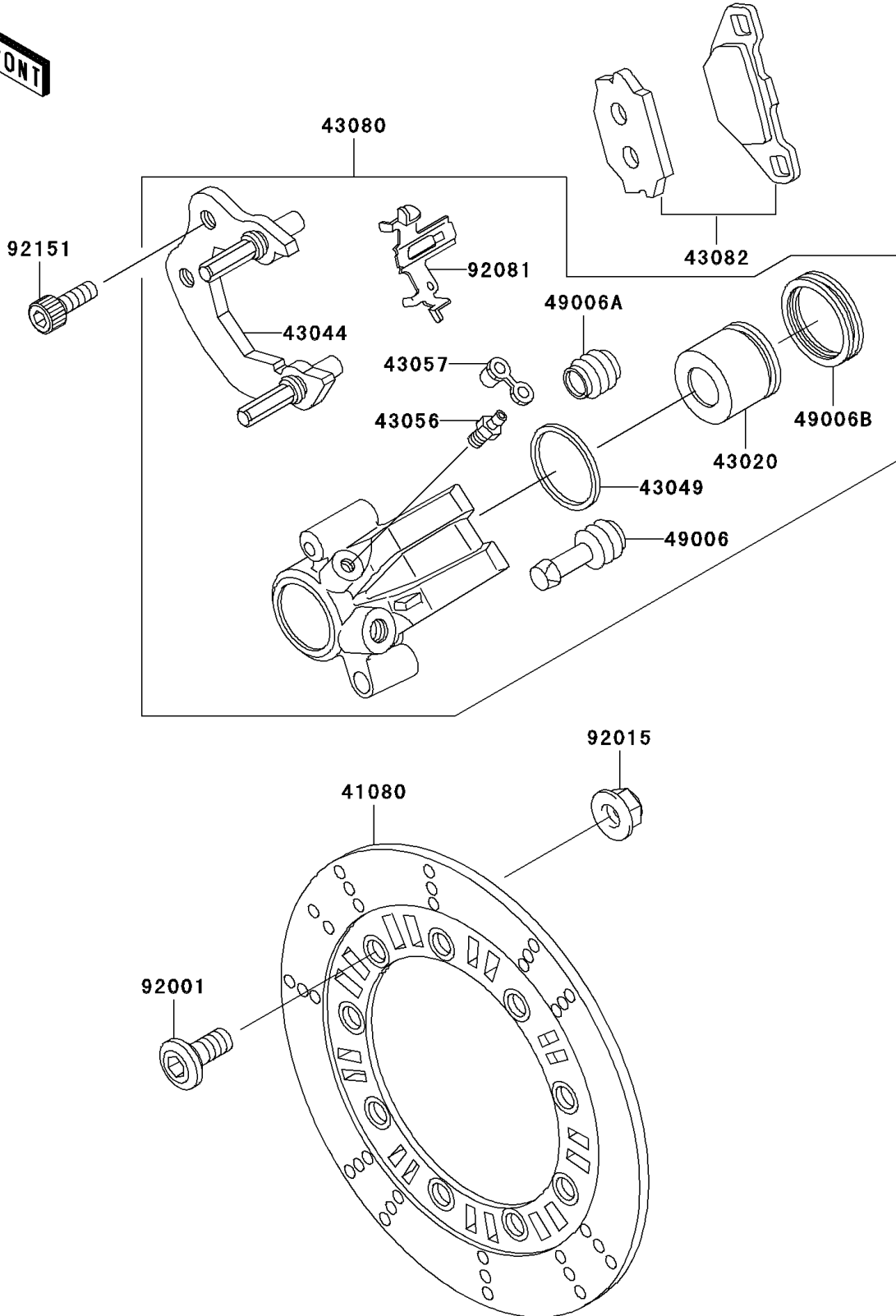

2004 KLR250 PARTS LIST

Front Brake(D21/D22)

ITEM NAME	PART NUMBER	QUANTITY
DISC,FR,SILVER (Ref # 41080)	41080-1145	1
PISTON-COMP-BRAKE (Ref # 43020)	43020-1082	1
HOLDER-COMP-CALIPER,FR,LH (Ref # 43044)	43044-1027	1
PACKING,PISTON SEAL (Ref # 43049)	43049-1095	1
BREATHER-BRAKE (Ref # 43056)	43056-1054	1
CAP-BREATHER (Ref # 43057)	43057-003	1
CALIPER-SUB-ASSY,FR,LH,BLACK (Ref # 43080)	43080-5019-DJ	1
PAD-ASSY-BRAKE,FR (Ref # 43082)	43082-1056	1
BOOT,CALIPER (Ref # 49006)	49006-1054	1
BOOT,CALIPER (Ref # 49006A)	49006-1055	1
BOOT,PISTON (Ref # 49006B)	49006-1091	1
BOLT,DISC PLATE,6X16 (Ref # 92001)	92001-1987	9
NUT,LOCK,FLANGED,6MM (Ref # 92015)	92015-1339	9
SPRING,PAD (Ref # 92081)	92081-1341	1
BOLT,SOCKET,8X20 (Ref # 92151)	92151-1289	2