

2004 KLR250 PARTS DIAGRAM

Swingarm

F2141

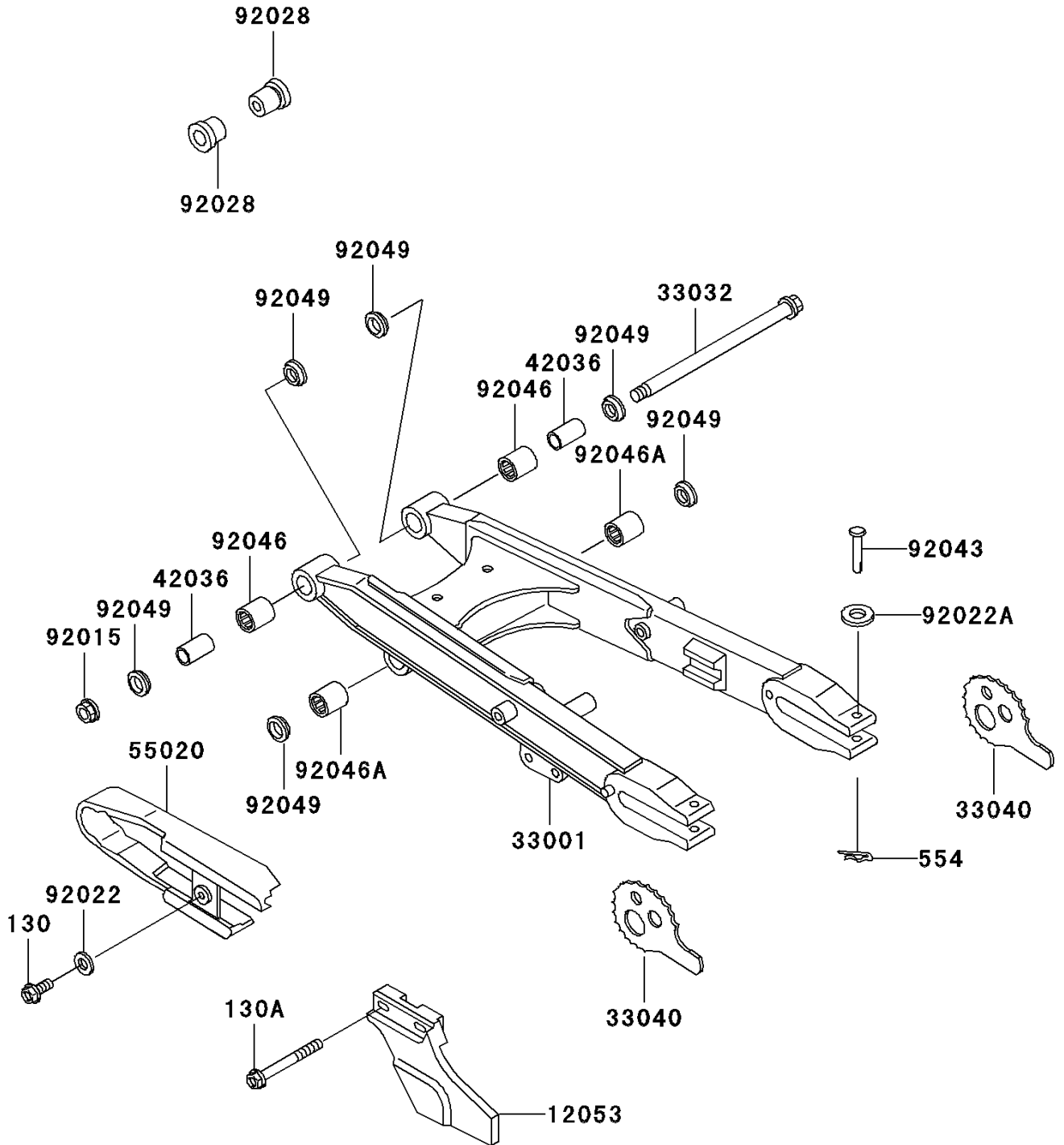

2004 KLR250 PARTS LIST

Swingarm

ITEM NAME	PART NUMBER	QUANTITY
BOLT-FLANGED (Ref # 130)	130G0512	1
BOLT-FLANGED (Ref # 130A)	130L0645	2
PIN-SNAP (Ref # 554)	554A0600	2
GUIDE-CHAIN,RR (Ref # 12053)	12053-1104	1
ARM-COMP-SWING,SILVER NO.25 (Ref # 33001)	33001-1253-CE	1
SHAFT-SWING ARM (Ref # 33032)	33032-1108	1
ADJUSTER-CHAIN (Ref # 33040)	33040-1060	2
SLEEVE,15.1X20X42.5 (Ref # 42036)	42036-1103	2
GUARD,CHAIN,FR (Ref # 55020)	55020-1154	1
NUT,14MM (Ref # 92015)	92015-1459	1
WASHER,5.5X20X1.2 (Ref # 92022)	92022-104	1
WASHER,6.2X11X1.5 (Ref # 92022A)	92022-183	2
BUSHING,SWING ARM (Ref # 92028)	92028-1261	2
PIN,6X44.5 (Ref # 92043)	92043-1110	2
BEARING-NEEDLE,BM202726 (Ref # 92046)	92046-1110	2
BEARING-NEEDLE,BTM202730 (Ref # 92046A)	92046-1113	2
SEAL-OIL,ARM (Ref # 92049)	92049-1109	6