

# 2003 KLR250 PARTS DIAGRAM

Ignition System

E1830

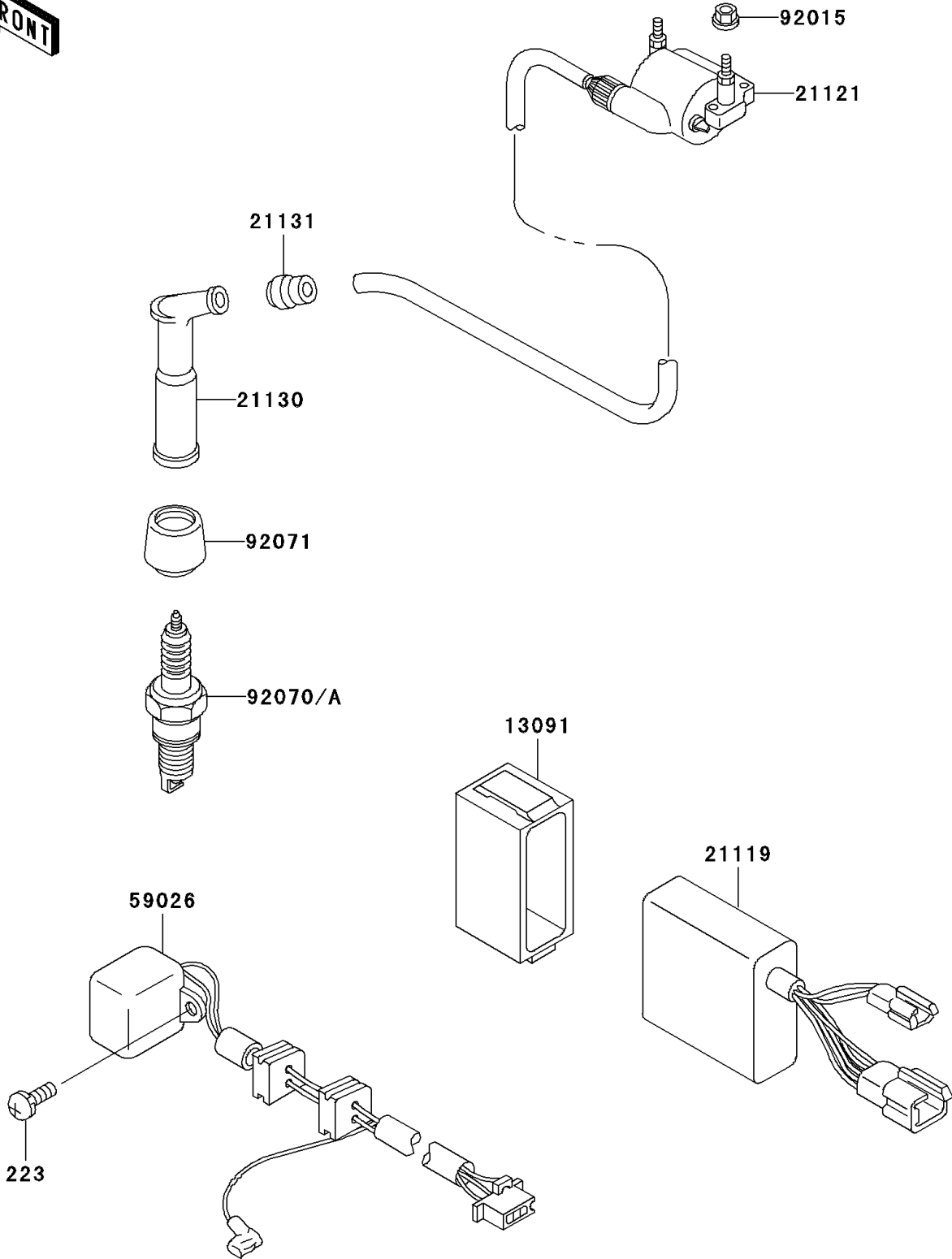

## 2003 KLR250 PARTS LIST

### Ignition System

ITEM NAME	PART NUMBER	QUANTITY
SCREW-PAN-WS-CROS (Ref # 223)	223B0514	2
HOLDER,IGNITER (Ref # 13091)	13091-1271	1
IGNITER (Ref # 21119)	21119-1180	1
COIL-IGNITION (Ref # 21121)	21121-1118	1
CAP-SPARK PLUG (Ref # 21130)	21130-1002	1
GROMMET,HIGH TENSION (Ref # 21131)	21131-005	1
COIL-PULSING (Ref # 59026)	59026-1065	1
NUT,FLANGED,6MM (Ref # 92015)	92015-1193	2
PLUG-SPARK,DPR9EA-9(NGK) (Ref # 92070)	92070-1068	1
PLUG-SPARK,X27EPR-U9(ND) (Ref # 92070A)		1
GROMMET,PLUG CAP (Ref # 92071)	92071-1124	1