

1997 Lakota 300 PARTS DIAGRAM

Chassis Electrical Equipment

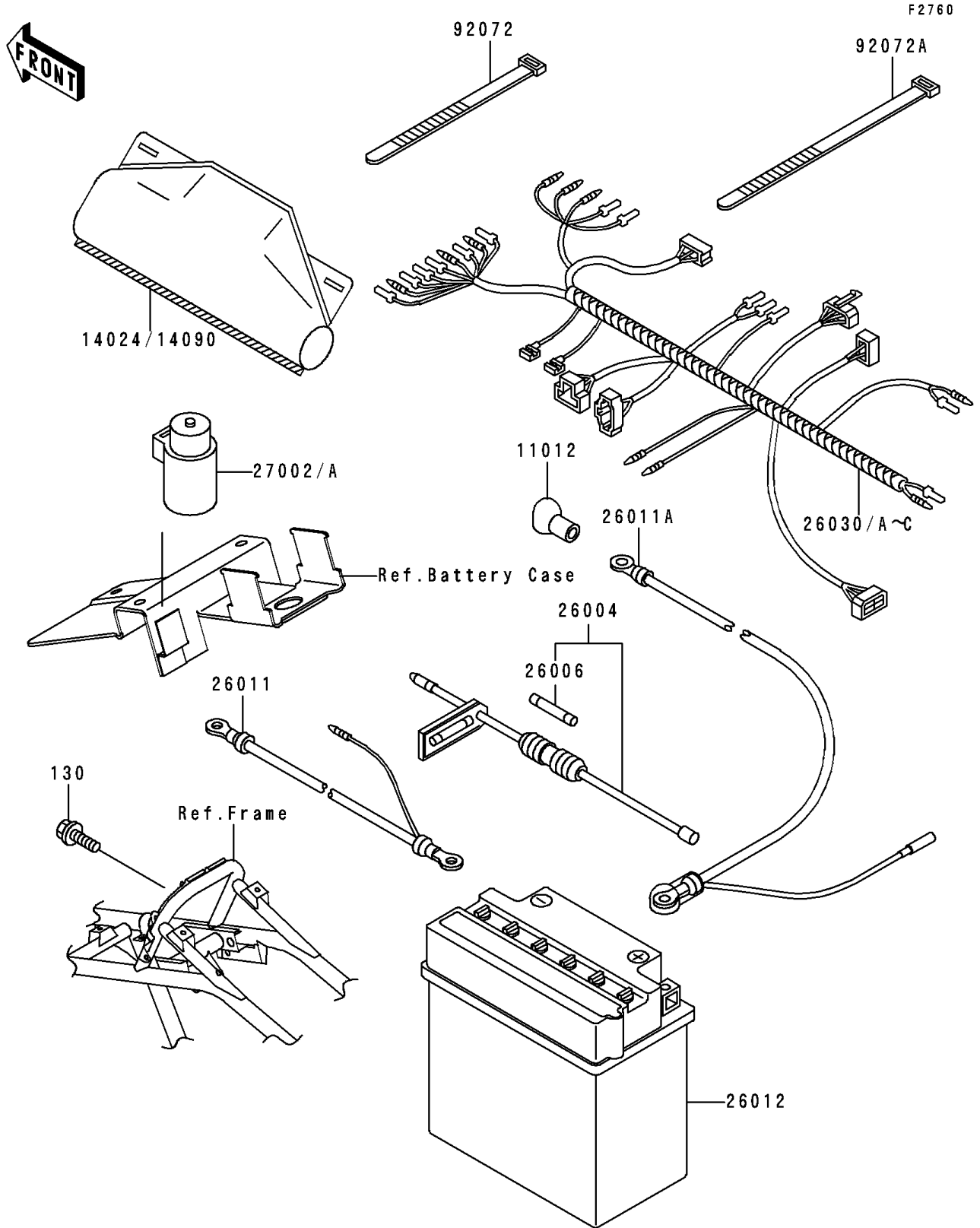

1997 Lakota 300 PARTS LIST

Chassis Electrical Equipment

ITEM NAME	PART NUMBER	QUANTITY
BOLT-FLANGED,6X12 (Ref # 130)	130B0612	1
CAP,TERMINAL (Ref # 11012)	11012-1354	1
COVER,COUPLER (Ref # 14090)	14090-1611	1
FUSE-ASSY (Ref # 26004)	26004-3715	1
FUSE,30A,L=30 (Ref # 26006)	26006-1059	2
WIRE-LEAD,BATTERY(-) (Ref # 26011)	26011-1601	1
WIRE-LEAD,BATTERY(+) (Ref # 26011A)	26011-1602	1
BATTERY,12V 14AH,YB14A-A2 (Ref # 26012)	26012-1146	1
HARNESS,MAIN (Ref # 26030A)	26030-1412	1
RELAY-ASSY (Ref # 27002A)	27002-1095	1
BAND,L=123 (Ref # 92072)	92072-030	2
BAND,L=188 (Ref # 92072A)	92072-1239	22