

1999 Lakota 300 PARTS DIAGRAM

Carrier(s)

F2520

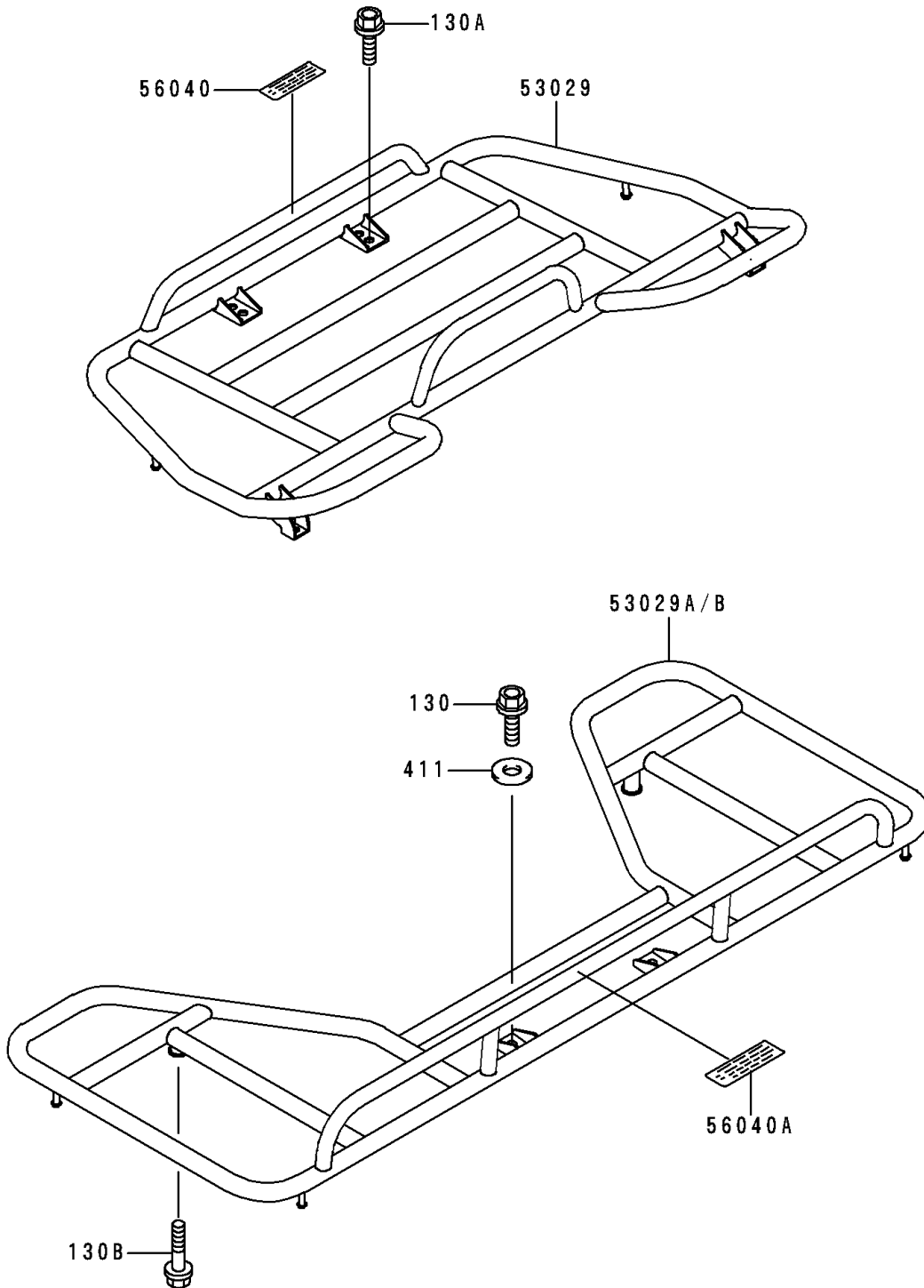

1999 Lakota 300 PARTS LIST

Carrier(s)

ITEM NAME	PART NUMBER	QUANTITY
BOLT-FLANGED,8X12 (Ref # 130)	130G0812	2
BOLT-FLANGED,8X16 (Ref # 130A)	130G0816	2
BOLT-FLANGED,6X30 (Ref # 130B)	130H0630	2
WASHER-PLAIN,8MM,BLACK (Ref # 411)	411F0800	2
CARRIER,FR,SILVER NO.40 (Ref # 53029)	53029-1148-5A	1
CARRIER,RR,SILVER NO.40 (Ref # 53029A)	53029-1149-5A	1
LABEL-WARNING,MAXIMUM LOAD (Ref # 56040)	56040-1264	1
LABEL-WARNING,MAXIMUM LOAD (Ref # 56040A)	56040-1265	1