

1998 Lakota 300 PARTS DIAGRAM

Fuel Tank

F2410

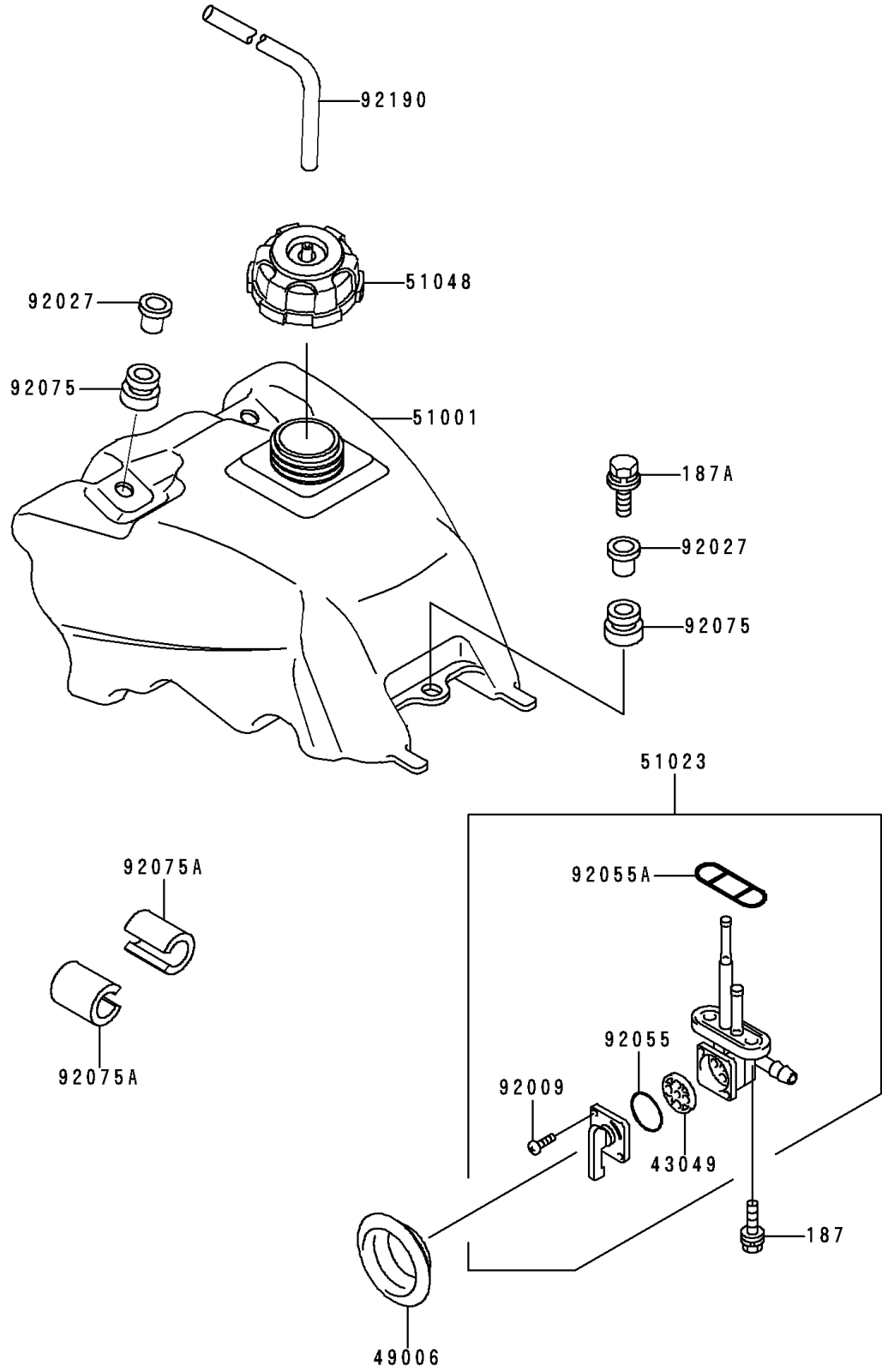

1998 Lakota 300 PARTS LIST

Fuel Tank

ITEM NAME	PART NUMBER	QUANTITY
BOLT-UPSET-WSP (Ref # 187)	187B0614	2
BOLT-UPSET-WSP (Ref # 187A)	187D0630	1
PACKING,FUEL TAP LEVER (Ref # 43049)	43049-1017	1
BOOT (Ref # 49006)	49006-1192	1
TANK-COMP-FUEL (Ref # 51001)	51001-1482	1
TAP-ASSY,FUEL (Ref # 51023)	51023-1146	1
CAP-ASSY-TANK,FUEL (Ref # 51048)	51048-1090	1
SCREW,3X5 (Ref # 92009)	92009-1123	2
COLLAR,L=16.1 (Ref # 92027)	92027-1847	3
RING-O,FUEL TAP LEVER (Ref # 92055)	92055-1111	1
RING-O,FUEL TAP PACKING (Ref # 92055A)	92055-1348	1
DAMPER (Ref # 92075)	92075-1787	3
DAMPER,FUEL TANK (Ref # 92075A)	92075-1835	2
TUBE,4.7X9.5X350 (Ref # 92190)	92190-1022	1