

1998 Lakota 300 PARTS DIAGRAM

Rear Hub

F2240

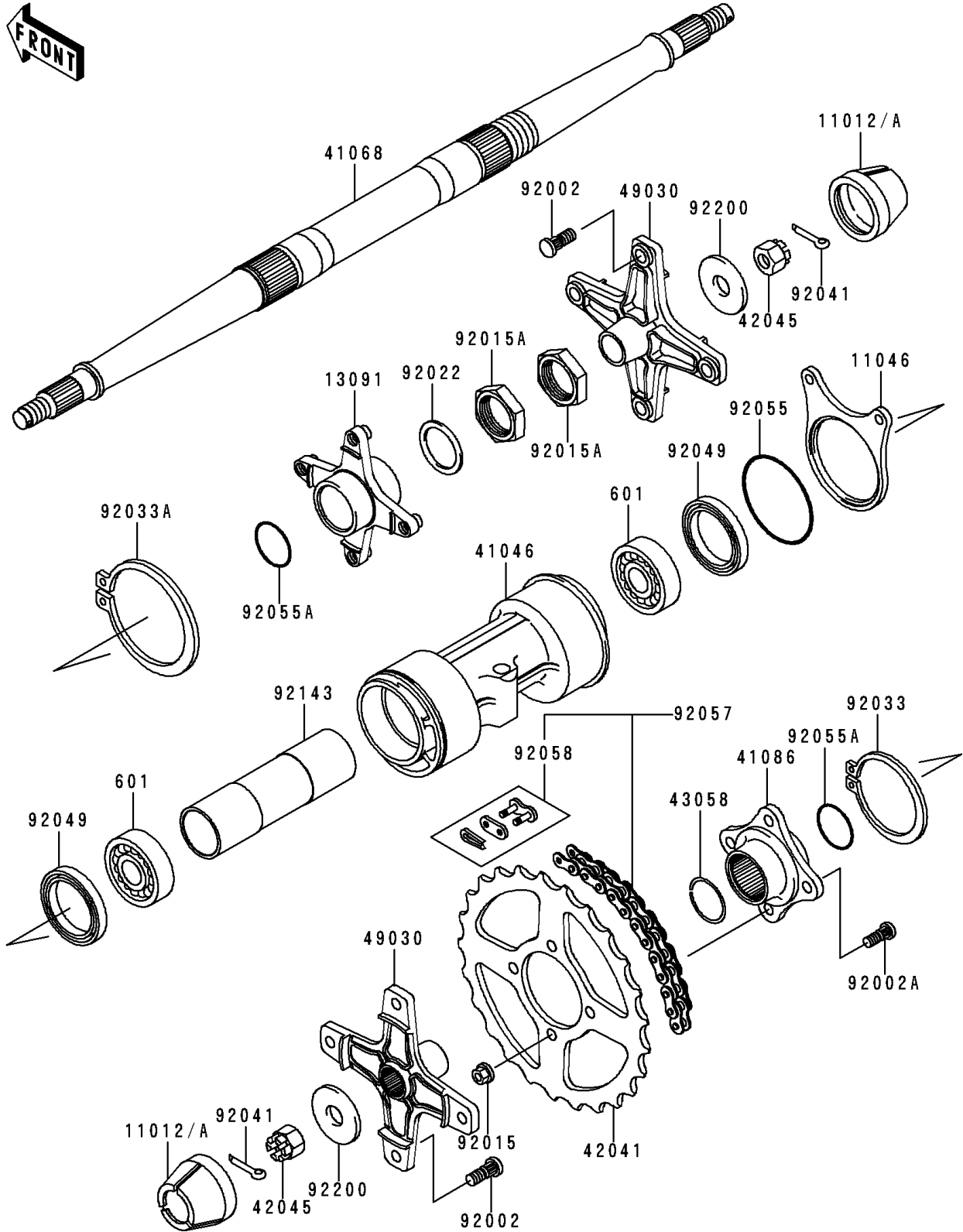

1998 Lakota 300 PARTS LIST

Rear Hub

ITEM NAME	PART NUMBER	QUANTITY
BEARING-BALL,#6008UU (Ref # 601)	601A6008UU	2
CAP,WHEEL (Ref # 11012A)	11012-1969	2
BRACKET,CALIPER (Ref # 11046)	11046-1062	1
HOLDER,DISC PLATE (Ref # 13091)	13091-1449	1
HOUSING-BEARING (Ref # 41046)	41046-1086	1
AXLE,RR (Ref # 41068)	41068-1235	1
FLANGE,REAR SPROCKET (Ref # 41086)	41086-1070	1
SPROCKET-HUB,43T (Ref # 42041)	42041-1433	1
NUT,CASTLE,18MM (Ref # 42045)	42045-018	2
RING,SNAP (Ref # 43058)	43058-1060	1
HUB,RR (Ref # 49030)	49030-1078	2
BOLT,10X30 (Ref # 92002)	92002-1388	8
BOLT,10MM (Ref # 92002A)	92002-1459	4
NUT,FLANGED,10MM (Ref # 92015)	92015-1335	4
NUT,LOCK,37MM (Ref # 92015A)	92015-1545	2
WASHER,37.5X48X2.3 (Ref # 92022)	92022-1746	1
RING-SNAP,95MM (Ref # 92033)	92033-1216	1
RING-SNAP,75MM (Ref # 92033A)	92033-1217	1
COTTER,4.0X35 (Ref # 92041)	92041-1053	2
SEAL-OIL (Ref # 92049)	92049-1237	2
RING-O,76MM (Ref # 92055)	92055-1213	1
RING-O,38MM (Ref # 92055A)	92055-1317	2
CHAIN,DRIVE,EK520SR-O2X100L (Ref # 92057)	92057-1393	1
JOINT-CHAIN (Ref # 92058)	92058-1060	1
COLLAR,L=159 (Ref # 92143)	92143-1036	1
WASHER,18.5X52X4.5 (Ref # 92200)	92200-1139	2