

1997 Lakota 300 PARTS DIAGRAM

Clutch

E1350

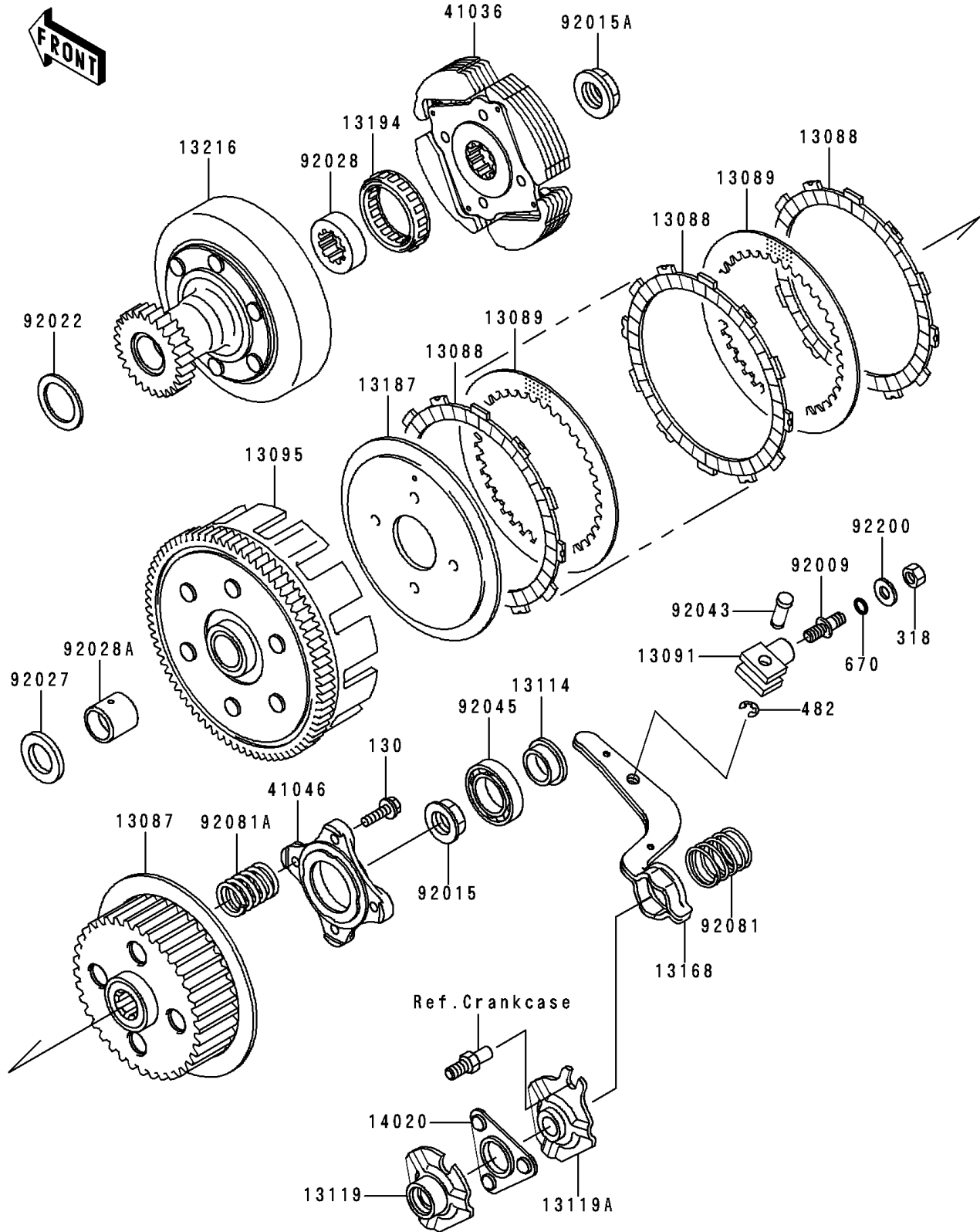

1997 Lakota 300 PARTS LIST

Clutch

ITEM NAME	PART NUMBER	QUANTITY
BOLT-FLANGED,6X20 (Ref # 130)	130P0620	1
NUT-HEX-SMALL,8MM (Ref # 318)	318B0800	1
CIRCLIP-TYPE-E,6MM (Ref # 482)	482J6000	1
O RING,8MM (Ref # 670)	670B1508	1
HUB-CLUTCH (Ref # 13087)	13087-1065	1
PLATE-FRICTION (Ref # 13088)	13088-041	1
PLATE-CLUTCH (Ref # 13089)	13089-1005	1
HOLDER,CLUTCH RELEASE (Ref # 13091)	13091-1341	1
HOUSING-COMP-CLUTCH (Ref # 13095)	13095-1365	1
PUSHER-CLUTCH (Ref # 13114)	13114-1056	1
CAM-RELEASE (Ref # 13119)	13119-1073	1
CAM-RELEASE (Ref # 13119A)	13119-1074	1
LEVER,CLUTCH RELEASE (Ref # 13168)	13168-1263	1
PLATE-CLUTCH OPERATING (Ref # 13187)	13187-1081	1
CLUTCH-ONEWAY (Ref # 13194)	13194-1055	1
GEAR-COMP (Ref # 13216)	13216-1149	1
RETAINER,CLUTCH RELEASE (Ref # 14020)	14020-1093	1
HUB-ASSY,CLUTCH,FR (Ref # 41036)	41036-1122	1
HOUSING-BEARING (Ref # 41046)	41046-1063	1
SCREW,CLUTCH RELEASE (Ref # 92009)	92009-1303	1
NUT,16MM (Ref # 92015)	92015-1465	1
NUT,18MM (Ref # 92015A)	92015-1512	1
WASHER,27.3X38X0.8 (Ref # 92022)	92022-1989	1
COLLAR,20.5X34X4 (Ref # 92027)	92027-1888	1
BUSHING,CLUTCH,FR (Ref # 92028)	92028-1370	1
BUSHING,CLUTCH (Ref # 92028A)	92028-1371	1
PIN,CLUTCH RELEASE (Ref # 92043)	92043-1230	1
BEARING-BALL,#6905 (Ref # 92045)	92045-036	1
SPRING (Ref # 92081)	92081-1681	1

1997 Lakota 300 PARTS LIST

Clutch

ITEM NAME	PART NUMBER	QUANTITY
SPRING,CLUTCH (Ref # 92081A)	92081-1848	1
WASHER,8.5X18X2.3 (Ref # 92200)	92200-1213	1