

# 1998 KE100 PARTS DIAGRAM

Front Fork

F2340

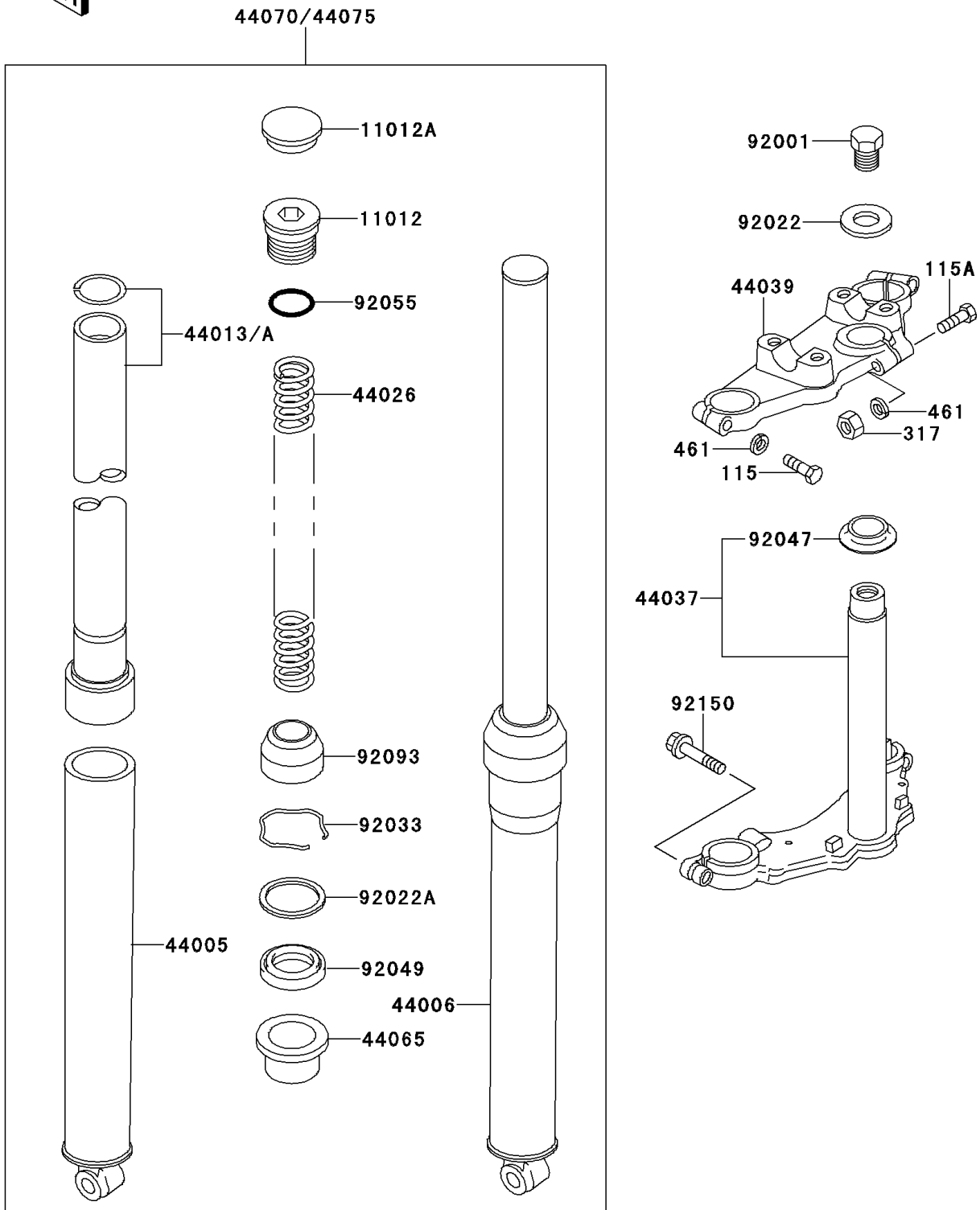

# 1998 KE100 PARTS LIST

## Front Fork

ITEM NAME	PART NUMBER	QUANTITY
BOLT-SMALL-UPSET (Ref # 115)	115B0835	2
BOLT-SMALL-UPSET (Ref # 115A)	115B0845	1
NUT-HEX-SMALL,8MM (Ref # 317)	317B0800	1
WASHER-SPRING,8MM (Ref # 461)	461F0800	3
CAP,SPRING (Ref # 11012)	11012-1126	2
CAP,FORK (Ref # 11012A)	11012-1127	2
PIPE-LEFT FORK OUTER (Ref # 44005)	44005-1076	1
PIPE-RIGHT FORK OUTER (Ref # 44006)	44006-1075	1
PIPE-FORK INNER (Ref # 44013)	44013-1070	2
SPRING-FRONT FORK (Ref # 44026)	44026-1120	2
HOLDER-FORK UNDER (Ref # 44037)	44037-1076	1
HOLDER-FORK UPPER (Ref # 44039)	44039-047	1
BUSHING-FRONT FORK (Ref # 44065)	44065-1014	2
DAMPER-SET-FORK (Ref # 44070)	44070-5055	1
BOLT (Ref # 92001)	92001-1327	1
WASHER (Ref # 92022)	92022-1198	1
WASHER,FRONT FORK OIL SEAL (Ref # 92022A)	92022-1241	2
RING-SNAP (Ref # 92033)	92033-1038	2
RACE,LOWER BEARING (Ref # 92047)	92047-004	1
SEAL-OIL,FRONT FORK (Ref # 92049)	92049-1067	2
RING-O (Ref # 92055)	92055-1087	2
SEAL,DUST (Ref # 92093)	92093-1065	2
BOLT,10X36 (Ref # 92150)	92150-1814	2